

GENERAL CATALOGUE

Lumen center.

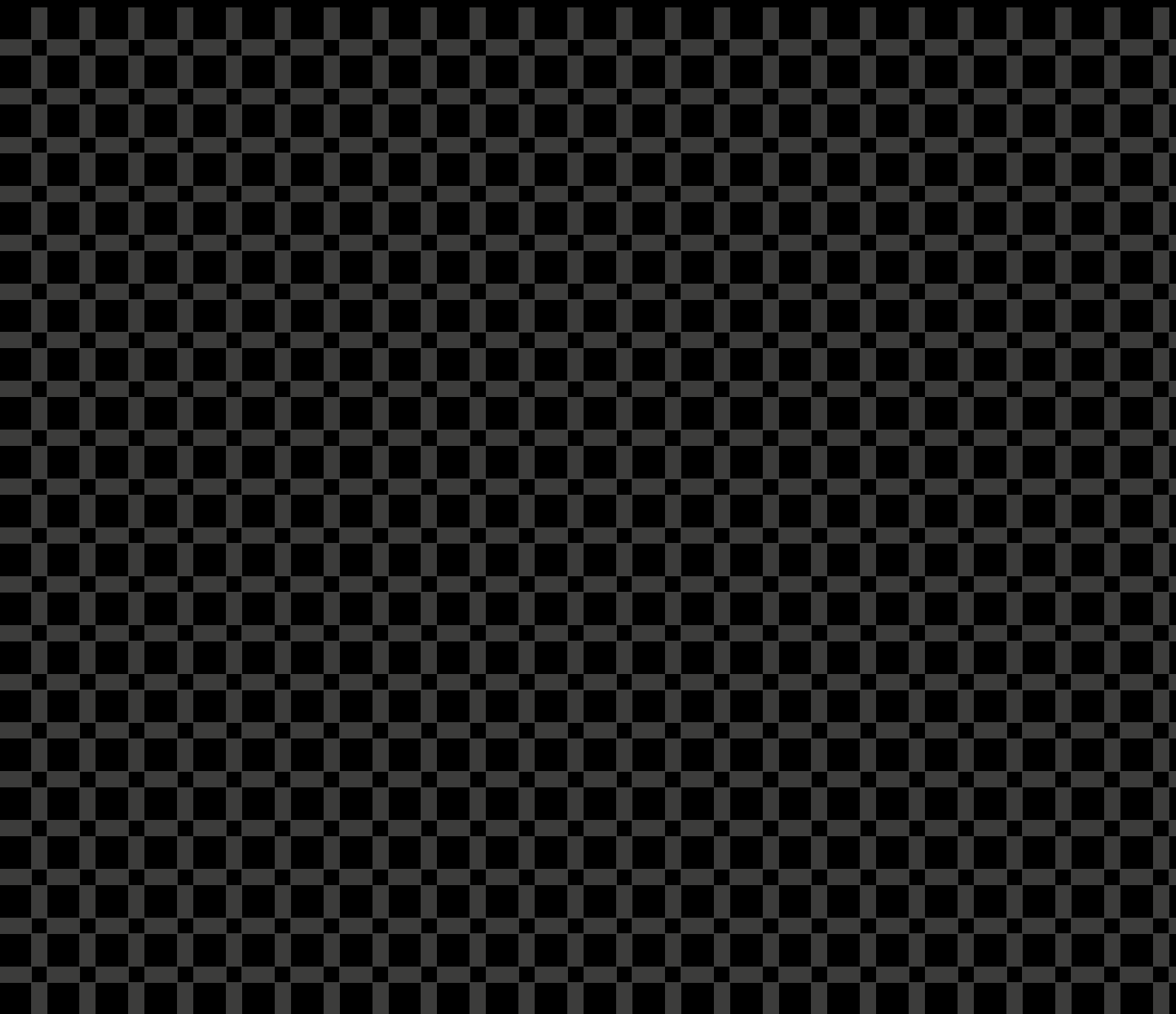

GENERAL CATALOGUE

lumencenteritalia.com

Lumen center.

_ Our History

LUMEN CENTER, fondata nel 1976 a La-Fare-les-Oliviers sotto la direzione artistica di Gilles Derain, ha una storia ricca e affascinante nel mondo del design e dell'illuminazione. Derain, un noto esponente del design contemporaneo francese e studioso dell'UAM (Union des Artistes Modernes), ereditò il suo approccio stilistico e progettuale dagli insegnamenti di Jacques Adnet e dallo studio del modernismo internazionale.

La lampada MCP, creata da Derain nel 1979 ed esempio della sua ricerca approfondita, è diventata un successo commerciale significativo, tanto da essere inclusa nella collezione permanente del Museo di Arti Decorative di Montreal.

Nel 1992, l'azienda viene acquisita da un imprenditore milanese, dando inizio a una fase di consolidamento della sua posizione nel mercato dell'illuminazione italiano e internazionale. La collaborazione con rinomati designer francesi, tra cui Jean-Michel Wilmotte, e l'alta qualità dei prodotti offerti hanno ulteriormente contribuito al successo dell'azienda.

Negli anni Novanta, LUMEN CENTER ha intrapreso un importante progetto di interior design e illuminazione per il Royal Pines Hotel di Urawa in Giappone chiamato "Life River" in collaborazione con VillaTosca Design, il Centro Europeo di Design di Panasonic. Questo progetto rappresenta l'elevata competenza tecnica e produttiva dell'azienda, evidenziando la sua flessibilità nel realizzare progetti su misura.

L'azienda ha continuato a distinguersi a livello internazionale con iniziative come sperimentazioni sulle sinestesie tra luce, colore e suono, l'utilizzo di sorgenti luminose alternative come gli OLED e studi sull'interazione tra luce e metabolismo umano.

Negli anni LUMEN CENTER è stata sponsor dell'illuminazione del food court del Padiglione Giappone ad Expo 2015 e ad oggi contribuisce all'illuminazione di opere d'arte importanti presso la Veneranda Pinacoteca Ambrosiana di Milano, dimostrando il suo impegno nel sostenere progetti culturali e artistici di rilievo.

Founded in 1976 in La Fare les Oliviers under the artistic direction of Gilles Derain, LUMEN CENTER has a rich and fascinating history in the world of design and lighting. Derain, a prominent exponent of contemporary French design and expert of the UAM (Union des Artistes Modernes), inherited his stylistic and design approach from the teachings of Jacques Adnet and the study of international modernism.

The MCP lamp, created from Derain in 1979 and an example of his in depth research, became a significant commercial success, so much so that it is included in the permanent collection of the Montreal Museum of Decorative Arts.

In 1992, the company was acquired by a Milanese entrepreneur, initiating a phase of consolidation of its position in the Italian and international illumination market. Collaboration with renowned French designers, including Jean Michel Wilmotte, and the high quality of the products offered further contributed to the company's success.

In the nineties LUMEN CENTER started an important interior design and illumination project for the Royal Pines Hotel in Urawa, Japan, which was entitled "Life River" and was realized in cooperation with VillaTosca Design, the European Centre for Design of Panasonic. This project represents the company's high level of technical and production expertise, highlighting its flexibility in realising customised projects.

The company has continued to distinguish itself internationally with initiatives such as experiments on synaesthesia between light, colour and sound, the use of alternative light sources such as OLEDs and studies on the interaction between light and human metabolism.

Over the years LUMEN CENTER has been the sponsor of the lighting of the food court of the Japan Pavilion at Expo 2015 and to date contributes to the lighting of important works of art at the Veneranda Pinacoteca Ambrosiana in Milan, demonstrating its commitment to supporting important cultural and artistic projects

L'histoire de LUMEN CENTER, une société fondée en 1976 dans la ville provençale de La-Fare-les-Oliviers sous la direction artistique de Gilles Derain, est la fois riche et fascinante dans le monde du design et de l'éclairage. Derain, un éminent représentant du design contemporain français et expert de l'UAM (Union des Artistes Modernes), a hérité son approche stylistique et conceptuelle des enseignements de Jacques Adnet et de l'étude du modernisme international.

Un exemple de sa recherche minutieuse est la lampe MCP, réalisée par Derain en 1979 et devenue un énorme succès commercial, au point d'être incluse dans la collection permanente du Musée des Arts Décoratifs de Montréal.

En 1992, la société fut reprise par un entrepreneur milanais et la collaboration consolidée avec des designers français de renom, dont Jean-Michel Wilmotte, ainsi que la haute qualité des produits proposés, permettent à l'entreprise de renforcer rapidement sa position sur la scène italienne et internationale de l'éclairage.

Au cours des années 90, l'entreprise entre en contact avec le centre de design européen de Panasonic, VillaTosca Design, créant conjointement un important et ambitieux projet de design d'intérieur et d'éclairage pour l'hôtel Royal Pines à Urawa, au Japon. Le projet s'appelle "Life River" et représente l'immense savoir-faire technique et de production de l'entreprise, ainsi que sa capacité à réaliser des projets "sur mesure" avec une grande flexibilité.

Depuis, l'entreprise n'a jamais cessé de se démarquer au niveau international, en menant une multitude d'initiatives, telles que des expériences sur la synesthésie entre la lumière, la couleur et le son, l'utilisation de sources alternatives telles que les OLED et des études sur l'interaction entre la lumière et le métabolisme humain.

Au fil des ans, LUMEN CENTER a également sponsorisé l'éclairage de l'aire de restauration du pavillon du Japon à l'Expo 2015 et assuré l'éclairage des œuvres importantes à la Veneranda Pinacoteca Ambrosiana de Milan, démontrant ainsi son engagement pour le soutien de projets culturels et artistiques importants.

Gegründet im Jahr 1976 in La-Fare-les-Oliviers unter der künstlerischen Leitung von Gilles Derain, hat LUMEN CENTER eine reiche und faszinierende Geschichte in der Welt des Designs und der Beleuchtung. Derain, ein prominenter Exponent des zeitgenössischen französischen Designs und Gelehrter des UAMs UAM (Union des Artistes Modernes), erbt seinen stilistischen und künstlerischen Ansatz von der Lehre von Jacques Adnet und die Studie des internationalen Modernismus.

Die MCP-Lampe wurde von Derain im Jahr 1979 kreiert und ist ein Beispiel von seiner tiefen Recherche. Sie wurde einen bedeutenden kommerziellen Erfolg, so dass sie wurde in der permanenten Kollektion des Montreal Museum of Decorative Arts inkludiert.

Im Jahr 1992 wurde die Firma von einem Unternehmer aus Mailand und damit fing die Phase der Konsolidierung seiner Position im Italienischen und internationalen Markt an. Kooperationen mit bekannten französischen Designer wie Jean-Michel Wilmotte und die hohe Qualität der angebotenen Produkte haben zum Erfolg des Unternehmens beigetragen.

In den 1990er Jahren realisierte LUMEN CENTER das wichtige Innendesign- und Beleuchtungsprojekt „Life River“ für das Royal Pines Hotel in Urawa, Japan. In Zusammenarbeit mit VillaTosca Design und dem European Design Centre von Panasonic zeigt dieses Projekt das technische Know-how und die Flexibilität des Unternehmens bei der Umsetzung maßgeschneiderter Projekte.

Das Unternehmen hat sich weiterhin international mit Initiativen wie Experimenten zur Synästhesie zwischen Licht, Farbe und Klang, dem Einsatz alternativer Lichtquellen wie OLEDs und Studien zur Interaktion zwischen Licht und menschlichem Stoffwechsel profiliert.

Im Laufe der Zeit sponserte LUMEN CENTER die Beleuchtung des Food-Courts des japanischen Pavillons auf der Expo 2015 und unterstützt weiterhin die Beleuchtung wichtiger Kunstwerke in der Veneranda Pinacoteca Ambrosiana in Mailand, was sein Engagement für kulturelle und künstlerische Projekte betont.

_ Made in Italy

—
Da quasi 50 anni, LUMEN CENTER è un laboratorio di grande importanza che persegue l'eccellenza. Fin dalle sue origini, l'azienda ha tratto ispirazione e forza creativa da esperienze e collaborazioni a livello internazionale, ma è nella produzione Made in Italy, che prevalentemente avviene nel nostro stabilimento di Santo Stefano Ticino, che trova la sua principale forza.

La qualità dei materiali, l'attenzione ai dettagli e la maestria artigianale sono i tratti distintivi del know-how aziendale. Pur mantenendo una solida tradizione artigianale, LUMEN CENTER continua a esplorare nuove soluzioni e ad adottare tecnologie all'avanguardia. Il risultato è la creazione di prodotti e in cui l'essenza del design si fonde armoniosamente con la perfetta funzionalità.

—
For almost 50 years LUMEN CENTER has been laboratory of great importance that pursues excellence. Since its beginnings, the company has drawn inspiration and creative strength from international experiences and collaborations, but it is in the Made in Italy production, which predominantly takes place in our factory in Santo Stefano Ticino, that this finds its main strength.

Quality materials, attention to detail, and artistry are the hallmarks of the company's know how. Alongside the solid traditional craftsmanship, LUMEN CENTER continues to explore new solutions and to adopt cutting edge technology. The outcome is the creation of products in which the essence of the design blends harmoniously with perfect functionality

—
Depuis près de 50 ans, LUMEN CENTER est un laboratoire de grande envergure qui vise l'excellence. Depuis le début, l'entreprise a su puiser son inspiration et sa force créative dans les expériences et les collaborations internationales, mais son plus grand atout, c'est la production strictement Made in Italy, qui se déroule principalement dans son usine de Santo Stefano Ticino.

Qualité des matériaux, souci du détail et savoir-faire artisanal

—
sont les maîtres-mots du savoir-faire de l'entreprise. Dans le sillage d'une longue tradition artisanale, LUMEN CENTER continue d'expérimenter de nouvelles solutions et des technologies de pointe, donnant vie à des produits qui conjuguent admirablement la quintessence du design et une parfaite fonctionnalité.

—
Seit fast 50 Jahren ist LUMEN CENTER ein Labor von großer Bedeutung, das nach Exzellenz strebt. Seit seinen Anfängen schöpft das Unternehmen Inspiration und kreative Kraft aus internationalen Erfahrungen und Kooperationen, aber seine größte Stärke liegt in der Produktion "Made in Italy", die überwiegend in unserem Werk in Santo Stefano Ticino stattfindet.

Hochwertige Materialien, Liebe zum Detail und Kunstfertigkeit sind die Markenzeichen des Know-hows des Unternehmens. Neben der soliden traditionellen Handwerkskunst erforscht LUMEN CENTER immer wieder neue Lösungen und setzt modernste Technologien ein. Das Ergebnis ist Produkte, bei denen sich die Essenz des Designs harmonisch mit perfekter Funktionalität verbindet.







Photos by Emma Onesti

_ Index

	ASTOLFO Collection	274	HINODE
136	ASTOLFO		
138	ASTOLFO HT		ICE Family
		220	FULLMOON
70	BLUM	218	ICELIGHT
		216	SUMO
	BRAC-BRICK-DOMINO System		
290	BRAC	126	KIRON
292	BRICK QUADRO		
292	BRICK RETTO		LUXSI Collection
294	DOMINO	110	LUXSI 09
		112	LUXSI 11
278	BRAWALL		
		28	MCP
	CHIOCCIOLA Family		
118	CHIOCCIOLA 02	40	MJA
120	CHIOCCIOLA 09		
122	CHIOCCIOLA 11		MORGANA & SIBYLLA Collection
		144	MORGANA
264	CONCORDE	146	SIBYLLA
46	DIANE		ODILE Family
		182	ODILE 21
34	EAGLE	184	ODILE S - M
	EGO Family	150	OUTLINE
260	EGO 11 - 12		
258	EGO L - XL - XXL	74	ORBIT
	FLAT Collection		PLANETS Collection
160	FLAT	174	PLANETS 08
162	FLAT RING	174	PLANETS 13
164	FLAT SATURN		
		52	QUADRO
268	GILLES		
		104	SEAFLOWER
90	GRUS		

ALPHABETIC

	SKYLINES Family
98	SKYLINES S&P
100	SKYLINES SUSPENSION
	TAKÉ Family
230	TAKÉ PLUS BT
234	TAKÉ PLUS BT S&P
232	TAKÉ PLUS S3 - S4 - S5 - S6
238	TAKÉ OPEN AIR 03 - 10 - 11
238	TAKÉ OPEN AIR 21
	TMB Family
86	TMB 02
88	TMB 11
246	TØB
20	TORCHÉRE
24	TRYLON
80	VICTORY
	WASHINGTON Collection
62	WASHINGTON
66	WASHINGTON 40° Lim. Ed.
	ZERO Family
200	ZERO 02
202	ZERO 09
204	ZERO 11
198	ZERO 40 - 50 - 60 - 80
196	ZERO S - M - L
	<hr/>
302	COLOURS & FINISHES

_ Index

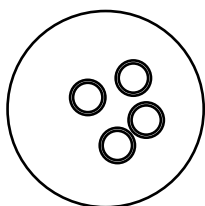

290 **BRAC 01 - 04 - 06 - 10**

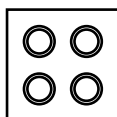

292 **BRICK QUADRO 01 - 04**



292 **BRICK RETTO 02 - 04**

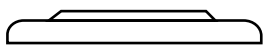

198 **ZERO 40 - 50 - 60 - 80**

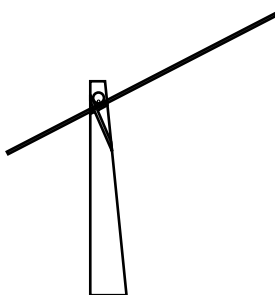

136 **ASTOLFO**

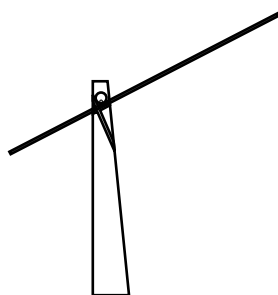

138 **ASTOLFO HT**



122 **CHIOCCIOLA 11**

CEILING

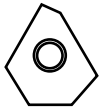

294 **DOMINO**



98 **SKYLINES S&P S-M**

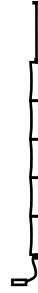

234 **TAKÉ PLUS BT S&P 04 -05 -06**

FLOOR



120 **CHIOCCIOLA 09**

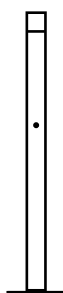

264 **CONCORDE**



260 **EGO 11 - 12**

_ Index

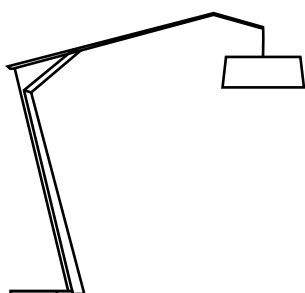

90 **GRUS**

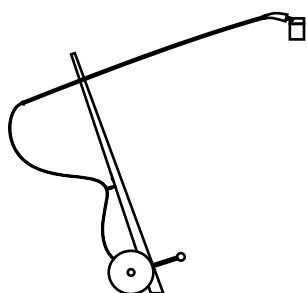

126 **KIRON**

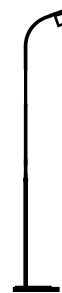

112 **LUXSI 11**

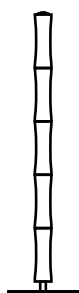

230 **TAKÉ PLUS BT 04 - 05 - 06**

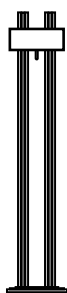

88 **TMB 11**



OUTDOOR
238 **TAKÉ OPEN AIR 03-10-11**



258 **EGO L - XL - XXL**

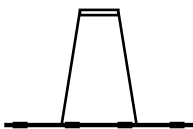

160 **FLAT 04 - 05 - 06**

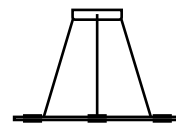

162 **FLAT RING 3 - 6 - 12**

FLOOR



110 **LUXSI 09**

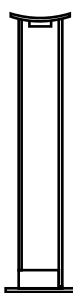

28 **MCP**



104 **SEAFLOWER**



80 **VICTORY**



202 **ZERO 09**

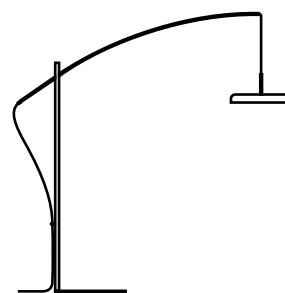

204 **ZERO 11**

SUSPENSION

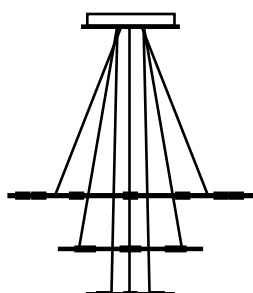

164 **FLAT SATURN 1 - 2 - 3**

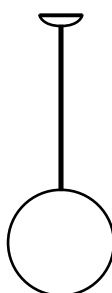

220 **FULLMOON 20 - 30 - 45 - 60**

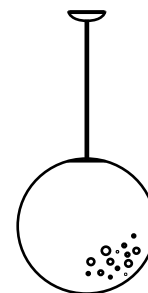

218 **ICELIGHT 20 - 30 - 45 - 60**

_ Index



144 **MORGANA S - M - L**

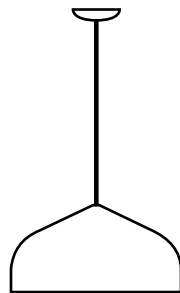

184 **ODILE S - M**

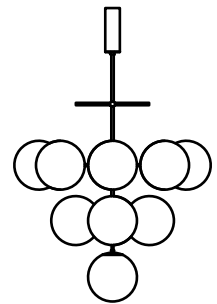

174 **PLANETS 08-13**

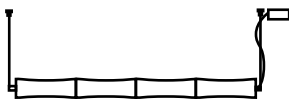

232 **TAKÉ PLUS S3 - S4 - S5 - S6**



246 **TØB 30 - 50 - 80**

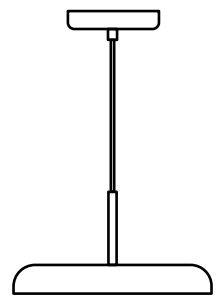

196 **ZERO S - M - L**

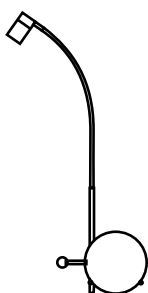

118 **CHIOCCIOLA 02**

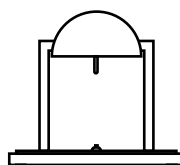

46 **DIANE**

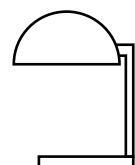

40 **MJA**

SUSPENSION



146 **SIBYLLA S - M - L**

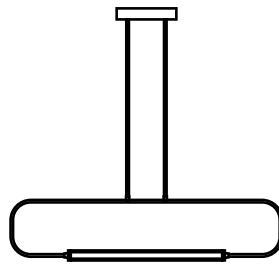

100 **SKYLINES SUSPENSION S - M**

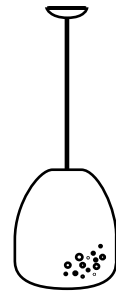

216 **SUMO S - M - L**

TABLE

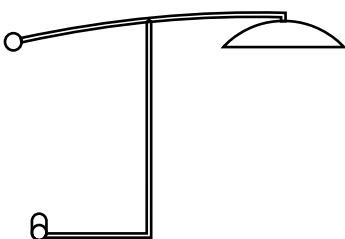

74 **ORBIT**

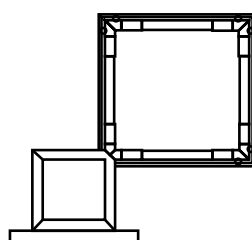

52 **QUADRO**

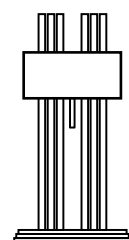

86 **TMB 02**

_ Index

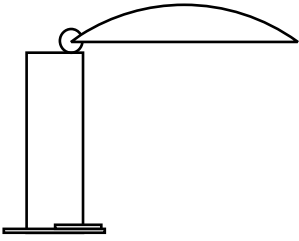

62 **WASHINGTON**

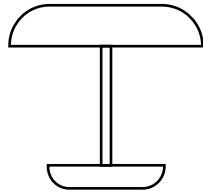

200 **ZERO 02**



70 **BLUM**

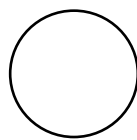

278 **BRAWALL S - M - L**

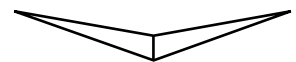

34 **EAGLE**



150 **OUTLINE**



238 **OUTDOOR
TAKÉ OPEN AIR 21**



20 **TORCHÈRE**

TABLE

WALL

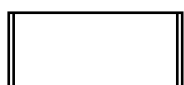

268 **GILLES**



274 **HINODE**

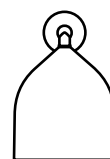

182 **ODILE 21**



24 **TRYLON**





_ Gilles Derain

–
Gilles Derain è stato un intermediario nel commercio di quadri dei maestri all'età di vent'anni, ma successivamente ha deciso di formarsi nel design frequentando il mercato delle pulci. È diventato uno specialista rinomato nella storia dell'arts décoratifs e un precursore del "syndrome de la tôle époxy noire". Alcune delle sue opere più famose includono la lampada "MCP Merci Chareau Pierre" e l'applique murale "Torchére".

–
Gilles Derain was an intermediary in the trade of master paintings at the age of twenty, but later decided to study design by frequenting flea markets. He became a renowned specialist in the history of arts décoratifs and a precursor of the "syndrome de la tôle époxy noire". Some of his most famous works include the floor lamp "MCP Merci Chareau Pierre" and the wall lamp "Torchére".

–
Gilles Derain était un intermédiaire dans le commerce des tableaux de maîtres à l'âge de vingt ans, mais il a ensuite décidé de étudier le design en fréquentant les marchés aux puces. Il est devenu un spécialiste renommé de l'histoire des arts décoratifs et un précurseur du "syndrome de la tôle époxy noire". Certaines de ses œuvres les plus célèbres incluent le lampadaire "MCP Merci Chareau Pierre" et l'applique murale "Torchére".

–
Gilles Derain war im Alter von zwanzig Jahren ein Vermittler im Handel mit Gemälden der Meister, entschied sich jedoch später, sich im Design zu spezialisieren, indem er Flohmärkte besuchte. Er wurde ein angesehenener Experte für die Geschichte der arts décoratifs und ein Vorläufer des "syndrome de la tôle époxy noire". Einige seiner berühmtesten Werke sind die Lampe "MCP Merci Chareau Pierre" und die Wandlampe "Torchére".



_ Torchère

Design G. Derain, 1984

ANTICHE SUGGESTIONI

Disegnata nel 1984 da Gilles Derain, Torchère richiama il fascino delle antiche torce da muro. La struttura in metallo ancorata a parete diffonde nell'ambiente un'illuminazione indiretta e diffusa.

ANCIENT CHARM

Designed in 1984 by Gilles Derain, Torchère recalls the charm of old wall torches. The metal structure anchored to the wall spreads indirect and diffuse lighting into the room.

CHARME ANCIEN

Dessinée en 1984 par Gilles Derain, Torchère réinterprète le charme des anciennes torches murales. La structure métallique ancrée au mur, émane une lumière indirecte et diffuse.

ALTER CHARME

Entworfen 1984 von Gilles Derain, erinnert Torchère an den Reiz der alten Wandfackeln. Die Struktur aus Metall, die an der Wand fixiert ermöglicht die Verbreitung eines indirekten und suggestiven Lichtes im Raum.

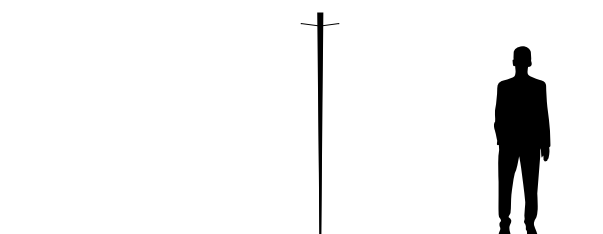

TORCHÈRE

Wall lamp



—
Lampada da parete realizzata in metallo con attacco a terra.
Sorgente LED integrata e dimmer a pedale incluso. Disponibile in
nero opaco, bianco opaco ed oro verniciato.

—
Wall lamp made of metal with floor socket. Embedded LED lighting
source and pedal dimmer included. Available in matte black, matte
white and painted gold.

—
Applique murale en métal avec prise de terre. Source LED intégrée
et variateur d'intensité à pédale inclus. Disponible en noir mat, blanc
mat et or peint.

—
Wandlampe aus Metall mit Stecker auf dem Boden. Integrierte
LED-Lichtquelle und Pedal-Dimmer. Verfügbar mit Verzierungen in
mattschwarz, mattweiß oder lackiertem Gold.

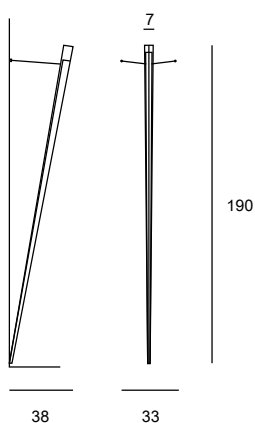

■ 102 Matte Black
□ 106 Matte White
■ 164 Painted Gold

Cable: Black, Transparent

LED 28W 2845lm 3000K CRI>90
Foot dimmer

CE  Classe I IP20





_ Trylon

Design G. Derain, 1987

TRIANGOLO DI LUCE

Disegnata nel 1987 da Gilles Derain, Trylon è caratterizzata dalla silhouette sottile e raffinata a pilone triangolare.

TRIANGLE OF LIGHT

Designed in 1987 by Gilles Derain, Trylon is characterised by its slim and refined triangular silhouette.

TRIANGLE DE LUMIÈRE

Dessinée en 1987 par Gilles Derain, l'applique Trylon se caractérise par sa silhouette triangulaire élancée et raffinée.

DREIECK AUS LICHT

Entworfen im Jahr 1987 von Gilles Derain, zeichnet sich Trylon durch ihre schmale, raffinierte dreieckige Silhouette.



TRYLON

Wall lamp



—
Lampada da parete realizzata in alluminio con sorgente LED integrata ed alimentatore elettronico dimmerabile TRIAC.
Disponibile in nero opaco, bianco opaco ed oro verniciato.

—
Wall lamp made of aluminium with embedded LED lighting source and TRIAC dimmable electronic power supply . Available in matte black, matte white and painted gold.

—
Applique murale en aluminium avec source LED intégrée et driver dimmable Triac. Disponible en noir mat, blanc mat et or peint.

—
Wandlampe aus Aluminium mit integrierter LED-Lichtquelle und TRIAC dimmbarer Stromversorgung. Verfügbar in mattschwarz, mattweiß und lackiertem Gold.

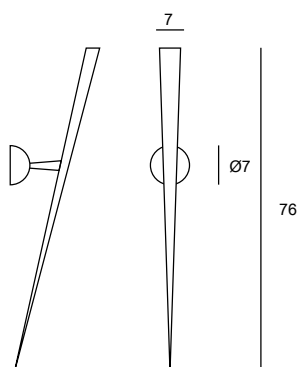

102 Matte Black
 106 Matte White
 164 Painted Gold

LED 8W 540lm 2700K CRI>90
Dimmable TRIAC



 Classe I IP20





MCP

Design G. Derain, 1979

“MERCİ CHAREAU PIERRE”

Disegnata nel 1979 da Gilles Derain in onore dell'architetto francese Pierre Chareau, MCP è caratterizzata dalla solidità delle linee e ad un'estetica senza tempo dall'allure industriale.

“MERCİ CHAREAU PIERRE”

Designed in 1979 by Gilles Derain in honour of the renowned French architect Pierre Chareau , MCP is characterized by the solidity of its lines and timeless aesthetic with industrial allure.

“MERCİ CHAREAU PIERRE”

Dessiné en 1979 par Gilles Derain en l'honneur de l'architecte français Pierre Chareau, MCP se caractérise par la solidité de ses lignes et une esthétique intemporelle aux allures industrielles.

“MERCİ CHAREAU PIERRE”

Entwickelt im Jahr 1979 von Gilles Derain zum bekannten französischen Architekt Pierre Chareaus Ehren zeichnet sich MCP durch die Solidität der Linien und die zeitlose Ästhetik mit industriellem Charme.

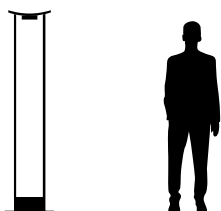





MCP
Floor lamp



—
Lampada da terra realizzata in alluminio laccato con sorgente LED integrata e dimmer a pedale incluso. Disponibile in nero opaco e bianco opaco.

—
Floor lamp made of lacquered aluminium with embedded LED lighting source and pedal dimmer included. Available in matte black or matte white.

—
Lampadaire en aluminium laqué avec source LED intégrée et variateur d'intensité à pédale. Disponible en noir mat et en blanc mat.

—
Stehlampe aus lackiertem Metall mit integrierten LED-Lichtquellen und Druckknopf mit Pedal-Dimmer. Verfügbar in Mattschwarz oder Mattweiß.

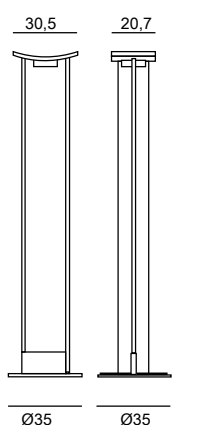

■ 102 Matte Black
□ 106 Matte White

LED 40W 3900lm 3000K CRI>90
Foot Dimmer

CE  Classe I IP20





_ Eagle

Design G. Derain, 1984

AQUILA DI LUCE

Disegnata nel 1984 da Gilles Derain, Eagle ha una linea essenziale e geometrica, ispirata al profilo grafico ed equilibrato dell'apertura alare di un'aquila in volo.

EAGLE OF LIGHT

Designed in 1984 by Gilles Derain, Eagle has an essential, geometric line, which was inspired by the graphic and balanced profile of the wingspan of a flying eagle.

UN AIGLE LUMINEUX

Dessinée en 1984 par Gilles Derain, Eagle affiche une ligne épurée et géométrique, inspirée de la silhouette graphique et équilibrée de l'envergure d'un aigle en vol.

EIN ADLER AUS LICHT

Entworfen im Jahr 1984 von Gilles Derain hat Eagle essentielle, geometrische Linien, die sich an das klare, balancierte Profil eines Adlers beim Flügelentfalten inspirieren.

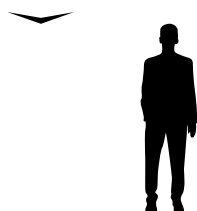

EAGLE**Wall lamp**

– Lampada da parete realizzata in alluminio con sorgente LED integrata a luce indiretta ed alimentatore elettronico dimmerabile TRIAC. Disponibile in nero opaco, bianco opaco ed oro verniciato.

– Wall lamp made of aluminium with indirect embedded LED lighting source and TRIAC dimmable electronic power supply. Available in matte black, matte white and painted gold.

– Applique murale en aluminium avec source de lumière indirecte LED intégrée et driver dimmable Triac. Disponible en noir mat, blanc mat et or peint.

– Wandlampe aus Aluminium mit indirekter integrierter LED-Lichtquelle und TRIAC dimmbarer Stromversorgung. Verfügbar in mattschwarz, mattweiß und lackiertem Gold.

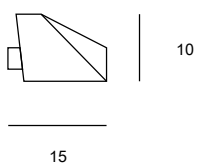
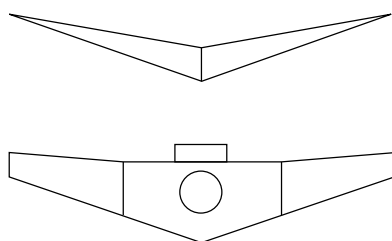

102 Matte Black
106 Matte White
164 Painted Gold

LED 20W 1560lm 3000K CRI>90
Dimmable TRIAC

CE Classe I IP20







— Jacques Adnet

— Jacques Adnet, formatosi presso la scuola di Arti Decorative, ha diretto la Compagnie des arts français promuovendo l'“Évolution dans la tradition”, collaborando con diversi artisti. Le sue lampade degli anni '20 e '30 erano all'avanguardia e certamente moderne, integrandosi perfettamente con il design modernista in metallo e vetro. Nel 1958, fu nominato ufficiale delle Arti e delle Lettere dal generale de Gaulle e nel 1959 divenne direttore dell'École nationale supérieure des arts décoratifs, ritirandosi nel 1970.

— Jacques Adnet, who graduated from the School of Decorative Arts, directed the Compagnie des arts français promoting the “Évolution dans la tradition” philosophy, collaborating with various artists. His lamps from the '20s and '30s were pioneering and distinctly modern, seamlessly integrating with the modernist design made of metal and glass. In 1958, he was appointed Officer of the Arts and Letters by General de Gaulle, and in 1959, he became the director of the École nationale supérieure des arts décoratifs, retiring in 1970.

— Jacques Adnet, formé à l'École des Arts Décoratifs, a dirigé la Compagnie des arts français en promouvant la philosophie de “l'Évolution dans la tradition”, en collaborant avec divers artistes. Ses lampes des années 20 et 30 étaient révolutionnaires et résolument modernes, s'intégrant parfaitement au design moderniste en métal et en verre. En 1958, il a été nommé Officier des Arts et des Lettres par le général de Gaulle, et en 1959, il est devenu directeur de l'École nationale supérieure des arts décoratifs, prenant sa retraite en 1970.

— Jacques Adnet, der an der Schule für dekorative Künste ausgebildet wurde, leitete die Compagnie des arts français und förderte die “Évolution dans la tradition”-Philosophie, indem er mit verschiedenen Künstlern zusammenarbeitete. Seine Lampen aus den 1920er und 1930er Jahren waren wegweisend und zweifellos modern und fügten sich nahtlos in das modernistische Design aus Metall und Glas ein. Im Jahr 1958 wurde er von General de Gaulle zum Offizier der Künste und Briefe ernannt, und 1959 wurde er Direktor der École nationale supérieure des arts décoratifs, wo er bis zu seinem Rücktritt im Jahr 1970 tätig war.



MJA

Design J.Adnet, 1930

MEMORY OF JACQUES ADNET

Disegnata nel 1930 da Jacques Adnet, MJA è contraddistinta da un'estetica minimale e pulita, dove la semplicità delle linee viene valorizzata dai materiali pregiati utilizzati.

MEMORY OF JACQUES ADNET

Designed in 1930 by Jacques Adnet, MJA is characterised by a clean, minimalist aesthetic, where the simplicity of the lines is enhanced by the fine materials used.

MEMORY OF JACQUES ADNET

Dessinée en 1930 par Jacques Adnet, la lampe à poser MJA se caractérise par une esthétique minimale et épurée, où la simplicité des lignes est rehaussée par les matériaux précieux utilisés.

MEMORY OF JACQUES ADNET

Entworfen im Jahr 1930 Jacques Adnet, zeichnet sich Mja durch eine minimale und saubere Ästhetik, wo die Einfachheit der Linien von den wertvollen Materialien aufgewertet wird.

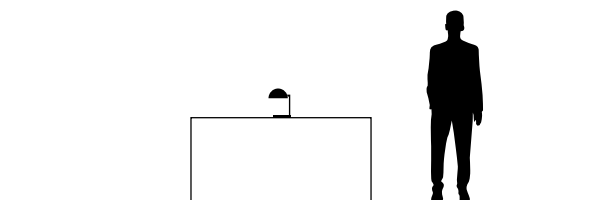





MJA
Table lamp



—
Lampada da tavolo realizzata in ottone e composta da una calotta sferica orientabile sorretta da un piedistallo dalla forma quadrangolare. Disponibile in cromo, oro 24K, nero opaco e bronzo verniciato.

—
Table lamp made of brass and composed of an adjustable, metallic spherical cap supported by a quadrangular pedestal. Available in chrome, 24K gold, matte black and painted bronze.

—
Lampe à poser en laiton composée d'une calotte sphérique réglable posée sur une simple base carrée. Disponible en chrome, or 24 carats, noir mat et bronze peint.

—
Tischlampe aus Messing mit einstellbarem sphärischem Schirm aus Metall unterstützt von einem viereckigen Säulenfuß. Verfügbar in Chrom, 24-karätigem Gold, mattem Schwarz und lackierter Bronze.

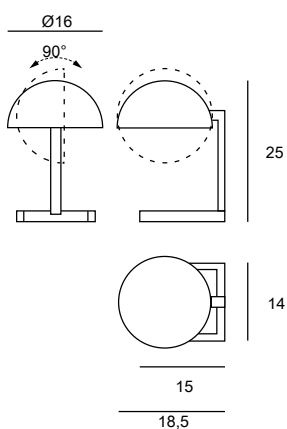

1xE14
ON-OFF







— Diane

Design J. Adnet, 1932

ALBA LUMINOSA

Disegnata nel 1932 da Jacques Adnet, Diane fonde la perfetta geometria modernista delle linee alla raffinatezza dei materiali, evocando l'immagine di una suggestiva alba nascente sulla linea dell'orizzonte.

BRIGHT SUNRISE

Designed in 1932 by Jacques Adnet, Diane combines the perfect modernist geometry of its lines with material refinement, evoking images of a glowing sunrise climbing slowly over the horizon.

AUBE LUMINEUSE

Dessinée en 1932 par Jacques Adnet, Diane réunit la parfaite géométrie moderniste des lignes au raffinement des matériaux, évoquant l'image d'une aube suggestive se levant à l'horizon.

GLÄNZENDE DÄMMERUNG

Entworfen im Jahr 1932 von Jacques Adnet kombiniert Diane die perfekte modernistische Geometrie mit der Feinheit der Materialien und beschwört dabei Bilder einer suggestiven aufgehenden Sonne auf der Horizontlinie.

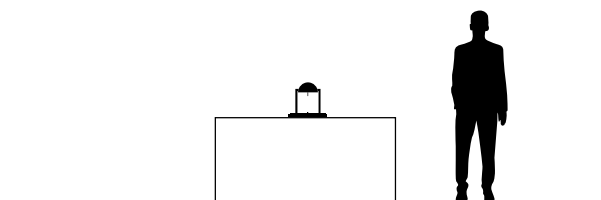





DIANE
Table lamp



—
Lampada da tavolo realizzata in ottone e composta da una calotta sferica orientabile sorretta da due bracci laterali. Disponibile in cromo, oro 24k e nero opaco, essa poggia su una doppia base rettangolare in ottone e in marmo nero Marquina, bianco di Carrara o Verde Alpi.

—
Table lamp made of brass composed of an adjustable spherical cap supported by two lateral brass arms. Available in chrome, 24K gold and matte black, it rests on a double rectangular base in brass and in Marquina black, Carrara white or Verde Alpi marble.

—
Lampe à poser en laiton, composée d'une calotte hémisphérique réglable en métal soutenue par deux bras latéraux. Disponible en chrome, or 24k et noir mat, elle repose sur une double base rectangulaire en laiton et marbre noir Marquina, marbre blanc de Carrare ou Vert des Alpes.

—
Tischlampe aus Messing mit sphärischem verstellbarem Schirm auf zwei seitlichen Armen. Verfügbar in Chrom, 24k Gold und Mattschwarz auf einem doppelten rechteckigen Grund aus Brass und Marquina schwarzem, Carrara weißem oder Verde Alpi Marmor.

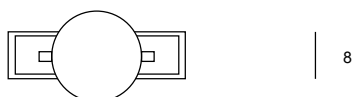
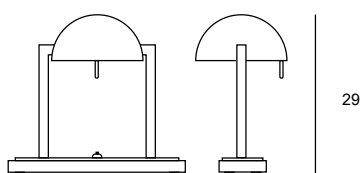

Ø16

32

102 Matte Black V Verde Alpi
150 Chrome N Black Marquina Marble
154 Gold 24K B White Carrara Marble

1xE14
ON-OFF switch on the base

CE IP20

Unit: cm





— Quadro

Design J.Adnet, 1929

RAFFINATE GEOMETRIE

Disegnata nel 1929 da Jacques Adnet, Quadro riflette l'eleganza, il minimalismo e lo stile sobrio e raffinato delle correnti razionaliste degli anni Trenta. Quadro fu realizzata negli anni Settanta su decisione dell'allora direttore artistico Gilles Derain.

REFINED GEOMETRIES

Designed in 1929 by Jacques Adnet, Quadro reflects the elegance, the minimalism and the refined and subdued style of rationalists from the 1930s. Quadro was created in the 1970s on the behest of then artistic director Gilles Derain.

GÉOMÉTRIES RAFFINÉES

Dessinée en 1929 par Jacques Adnet, la lampe Quadro témoigne l'élégance, le minimalisme et le style sobre et raffiné du rationalisme des années trente. Quadro a été créée dans les années 70 sur la décision du directeur artistique de l'époque, Gilles Derain.

RAFFINIERTE GEOMETRIEN

Entwickelt im Jahr 1929 von Jacques Adnet, Quadro spiegelt die Eleganz, den Minimalismus und den nüchternen und raffinierten Stil der 1930er wider. Quadro wurde in den 1970ern vom damaligen künstlerischen Leiter Gilles Derain realisiert.

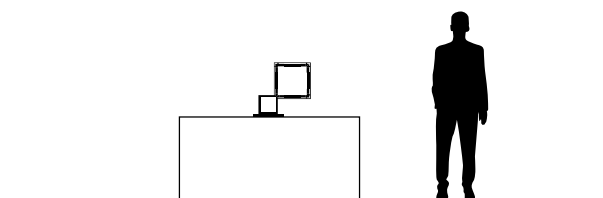





QUADRO**Table lamp**

—
Lampada da tavolo realizzata in tubolare d'ottone e con diffusori in resina acrilica sabbiata e cavo elettrico rivestito in tessuto nero. Sorgenti LED integrate e push dimmer sulla base. Disponibile in cromo, oro 24K e nero opaco; basi rispettivamente in marmo nero Marquina, bianco di Carrara e Verde Alpi.

—
Table lamp made of a tubular structure in brass with diffuser shade in sand acrylic resin and power cord covered in black fabric. Embedded LED lighting sources and push dimmer on the base. Available in chrome, 24K gold and matte black; bases in Marquina black, Carrara white and Verde Alpi marble respectively.

—
Lampe à poser composée d'une structure tubulaire en laiton avec diffuseurs en acrylique sablé et câble électrique en tissu noir. Sources lumineuses LED intégrées et variateur d'intensité avec bouton poussoir sur la base. Disponible en chrome, or 24K et noir mat avec base respectivement en marbre noir Marquina, marbre blanc de Carrara et marbre Vert des Alpes.

—
Tischlampe in Rohrform aus Messing mit sandgestrahlten Acrylharzdiffusoren und schwarzem stoffummanteltem Elektrokabel. Integrierte LED-Lichtquellen und Druckknopf mit Dimmer an der Basis. Verfügbar in Marquina schwarz, Carrara weiß und Verde Alpi Marmor.

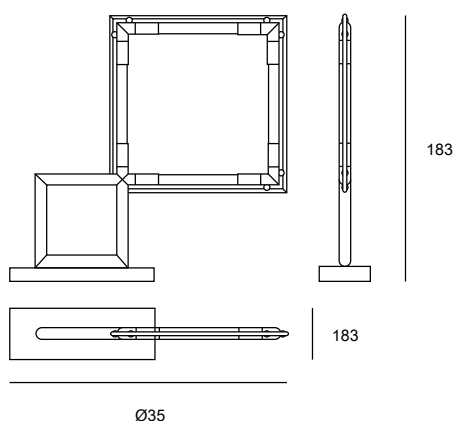

102 Matte Black V Verde Alpi
150 Chrome N Black Marquina Marble
154 Gold 24K B White Carrara Marble

LED 8x2W 2000lm 2700K CRI>90
Push dimmer on the base

CE IP20







— Jean - Michel Wilmotte

—

Nel 1975, Jean-Michel Wilmotte fondò il suo studio di architettura a Parigi, noto come Wilmotte & Associates, offrendo servizi che vanno dalla progettazione architettonica al design di prodotti e musei. Con un approccio eclettico e attento ai dettagli, Wilmotte & Associates realizza progetti in diversi settori, tra cui negozi, hotel di lusso e strutture pubbliche.

—

In 1975, Jean-Michel Wilmotte founded his architecture studio in Paris, known as Wilmotte & Associates, which offers services ranging from architectural design to product and museum design. With an eclectic and detail-oriented approach, Wilmotte & Associates undertakes projects in various sectors, including retail, luxury hotels, and public facilities.

—

En 1975, Jean-Michel Wilmotte a fondé son cabinet d'architecture à Paris, connu sous le nom de Wilmotte & Associates, qui propose des services allant de la conception architecturale au design de produits et de musées. Avec une approche éclectique et soucieuse du détail, Wilmotte & Associates réalise des projets dans différents secteurs, notamment les magasins, les hôtels de luxe et les infrastructures publiques.

—

Im Jahr 1975 gründete Jean-Michel Wilmotte sein Architekturbüro in Paris, bekannt als Wilmotte & Associates, das Dienstleistungen von der architektonischen Gestaltung bis zum Produktdesign und Museumsdesign anbietet. Mit einem eklektischen und detailorientierten Ansatz realisiert Wilmotte & Associates Projekte in verschiedenen Bereichen, darunter Einzelhandelsgeschäfte, Luxushotels und öffentliche Einrichtungen.

_ Washington Collection







— Washington

Design J.M. Wilmotte, 1983

SOBRIA ELEGANZA

Disegnata nel 1983 dall'architetto Jean-Michel Wilmotte per l'Ambasciata francese di Washington DC., si adatta con versatilità a qualunque contesto, dal soggiorno di casa all'ufficio, diffondendo una luce brillante e mirata.

SUBTLE ELEGANCE

Designed in 1983 by the French architect Jean Michel Wilmotte for the French embassy in Washington D.C., it adapts with versatility to any context, from the living room at home to the office, diffusing a bright and focused light.

ÉLÉGANCE SOBRE

Dessinée en 1983 par l'architecte français Jean-Michel Wilmotte pour l'ambassade de France à Washington D.C., cette lampe s'adapte avec brio à tous les contextes, du salon à la maison au bureau, en diffusant une lumière vive et concentrée.

DEZENTE ELEGANZ

Entwickelt im Jahr 1983 vom französischen Architekt Jean-Michel Wilmotte für die französische Botschaft in Washington D.C., passt Washington mit Einsatzflexibilität zu jedem Raum, vom Wohnzimmer zum Büro, indem sie ein helles und gezieltes Licht ausstrahlt.

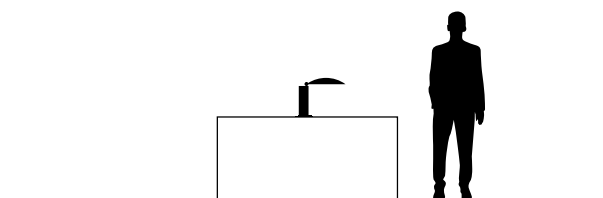

WASHINGTON**Table lamp**

—
Lampada da tavolo realizzata in metallo e ottone composta dal riflettore orientabile fissato su un corpo cilindrico. Sorgente LED integrata con dimmer su cavo in tessuto incluso. Disponibile in nero opaco, oro satinato o cromo e nelle nuove finiture in edizione limitata rame spazzolato e nichel nero satinato create per il suo 40° anniversario.

—
Table lamp made of brass and metal composed of an adjustable reflector fixed to a cylindrical body. Embedded LED lighting source with dimmer on textile cable included. Available in matte black, satin gold or chrome and in the new limited edition brushed copper and satin black nickel finishes created for its 40th anniversary.

—
Lampe à poser en métal et laiton composée d'un réflecteur orientable fixé sur un corps cylindrique. Source LED intégrée avec variateur d'intensité sur câble en tissu inclus. Disponible en noir mat, or satiné ou chrome et dans les nouvelles finitions en édition limitée en cuivre brossé et nickel noir satiné, réalisées à l'occasion de son 40e anniversaire.

—
Tischlampe aus Brass und Metall mit verstellbarem Reflektor fixiert auf einem zylindrischen Hauptteil. Integrierte LED-Lichtquellen mit Dimmer im Textilkabel. Verfügbar in Mattschwarz, satiniertem Gold oder Chrom und in den neuen limitierten Editionen mi Verzierungen in gebürstetem Kupfer und satiniertem schwarzem Nickel, entwickelt für seinen 40° Jahrestag.

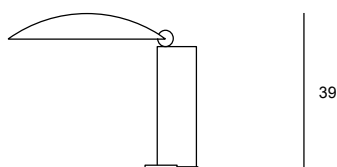
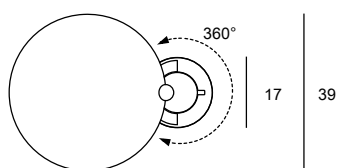

51

Unit: cm

102 Matte Black
150 Chrome
151 Satin Gold

158 Satin Black Nickel (40° Lim. Ed.)
163 Brushed Copper (40° Lim. Ed.)

LED 10W 900lm 2700K CRI>90
Push dimmer on cable

CE IP20



40'

LIMITED EDITION (1983 - 2023)



"The drawing of the Washington lamp is born from a gesture, like an evidence. A cup in balance on a base all bound by a kneecap."

_ J.M. Wilmotte









— Blum

Design B. Brousse, 1997

BOCCIOLO DI LUCE

Disegnata nel 1997 da Bernard Brousse, Blum è caratterizzata da linee semplici e armoniche che ricordano la silhouette stilizzata di un bocciolo di un fiore.

A BUD OF LIGHT

Designed in 1997 by Bernard Brousse, Blum is characterised by its simple, harmonic lines that recall the stylised silhouette of a flower bud.

BOURGEON DE LUMIÈRE

Dessinée en 1997 par Bernard Brousse, Blum présente des lignes simples et harmonieuses évoquant la silhouette stylisée d'un bouton de fleur.

EINE KNOSPE AUS LICHT

Entworfen im Jahr 1997 von Bernard Brousse, zeichnet sich Blum durch ihre einfachen und harmonischen Linien, die an die stilisierte Darstellung einer Blumenknospe erinnern.



BLUM
Wall lamp



— Lampada da parete realizzata in alluminio con sorgente LED integrata ed alimentatore elettronico dimmerabile TRIAC. Disponibile in nero opaco, bianco opaco ed oro verniciato.

— Wall lamp made of aluminium with embedded LED lighting source and TRIAC dimmable electronic power supply. Available in matte black, matte white and painted gold.

— Applique murale en aluminium avec source LED intégrée et driver dimmable Triac. Disponible en noir mat, blanc mat et or peint.

— Wandlampe aus Metall und verfügbar mit integrierter LED-Lichtquelle und TRIAC dimmbarer Stromversorgung. Verfügbar in mattschwarz, mattweiß und lackiertem Gold.

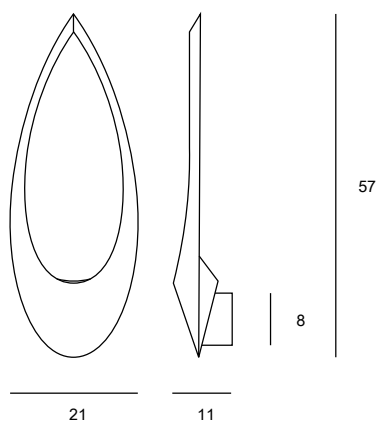

102 Matte Black
106 Matte White
164 Painted Gold

LED 20W 1560lm 3000K CRI>90
Dimmable TRIAC

CE IP20





Orbit

Design K. Gray, 1981

EQUILIBRIO SENZA TEMPO DI LUCE E DESIGN Disegnata nel 1981 da Kevin Gray, Orbit è caratterizzata da una forma dove la linea, la sfera e la semisfera si incontrano in un unico design. La sua morfologia ricorda la traiettoria descritta nello spazio dal moto di un pianeta intorno al sole che invita a interagire con la luce in una relazione emozionale.

TIMELESS BALANCE OF LIGHT AND DESIGN Designed in 1981 by Kevin Gray, Orbit is characterized by a form where the line, the sphere and the hemisphere blend in a unique design. Its morphology recalls the trajectory carved by the movement of a planet around the sun.

ÉQUILIBRE INTEMPOREL ENTRE LUMIÈRE ET DESIGN Dessinée en 1981 par Kevin Gray, la lampe Orbit se caractérise par un design unique où se rencontrent la ligne, la sphère et la demi-sphère. Sa morphologie rappelle la trajectoire dessinée par le mouvement d'une planète autour du soleil, et sa présence invite à interagir avec la lumière dans une relation émotionnelle.

ZEITLOSE BALANCE DES LICHTS UND DES DESIGNS Entwickelt im Jahr 1981 von Designer Kevin Gray, zeichnet sich Orbit durch ihre Form, in der die Linie, die Sphäre und die halbe Sphäre sich in einem einzigartigen Design mischen. Ihre Morphologie erinnert an die Bahnen der Planeten um die Sonne im Weltraum.

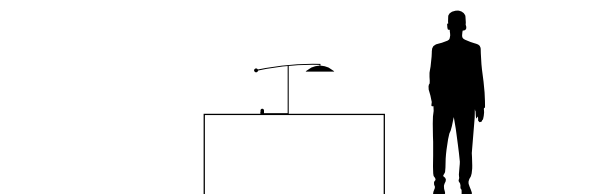





ORBIT**Table lamp**

—
Lampada da tavolo realizzata in ottone con diffusore e struttura orizzontale orientabile attorno all'asta verticale di 360°. Sorgente LED integrata con dimmer su cavo incluso. La connessione elettrica tra il driver a spina e il corpo lampada è di tipo magnetico. Disponibile in nero opaco, oro satinato e bronzo verniciato.

—
Table lamp made of brass with diffuser and horizontal structure rotatable around the vertical pole by 360°. Embedded LED lighting source with dimmer on cable included. The electrical connection between the plug-in driver and the lamp body is magnetic. Available in matte black, satin gold or painted bronze.

—
Lampe à poser en laiton avec diffuseur et structure horizontale pivotant autour de la tige verticale sur 360°. Source LED intégrée avec variateur d'intensité sur câble inclus. Le raccordement électrique entre le driver plug-in et le corps de la lampe est de type magnétique. Disponible en noir mat, or satiné et bronze peint.

—
Tischlampe aus Messing mit Diffuser und horizontale Struktur, die um 360° um den vertikalen Mast drehbar ist. Integrierte LED-Lichtquellen mit Dimmer im Kabel. Die elektrische Verbindung zwischen dem Steckertreiber und dem Lampenkörper ist magnetisch. Verfügbar in Mattschwarz, satiniertem Gold oder lackierter Bronze.

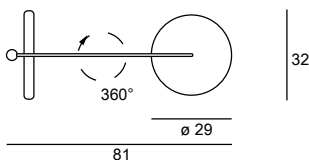
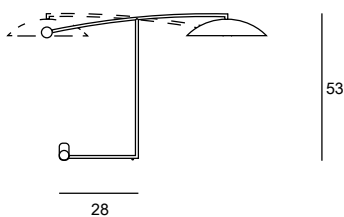

- 102 Matte Black
- 151 Satin Gold
- 175 Painted Bronze

LED PCB 7W 910lm 2700K CRI>90
Push dimmer on cable

CE IP20





— Victory

Design ArtOff, 1984

VITTORIA DI LUCE

Disegnata nel 1984 da ARTOFF (pseudonimo del Sig. Bobroff), Victory vede nella sottile struttura a “V” il suo segno caratterizzante, evocando non solo le forme archetipe del movimento modernista ma anche il ricordo di un antico trofeo simbolo di vittoria.

THE VICTORY OF LIGHT

Designed in 1984 by ARTOFF (pseudonym of Mr. Bobroff), Victory has in the subtle ‘V’ structure its defining mark, evoking not only the archetypal forms of the modernist movement but also the memory of an ancient trophy symbol of victory.

VICTOIRE DE LA LUMIÈRE

Dessiné en 1984 par ARTOFF (pseudonyme de Monsieur Bobroff), Victory se distingue par sa structure fine en “V” qui évoque non seulement les formes emblématiques du mouvement moderniste mais aussi le souvenir d’un ancien trophée, symbole de victoire.

DER SIEG DES LICHTS

Entworfen im Jahr 1984 von Artoff (Pseudonym von Mr. Bobroff), zeichnet sich Victory durch ihren dünnen „V“ Form, der nicht nur an die modernistische Bewegung erinnert, sondern auch an eine alte Trophäe -Symbol des Siegs- erinnert.

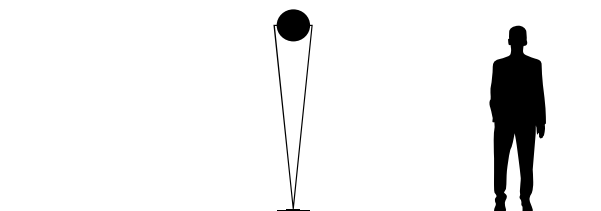

VICTORY

Floor lamp



—
Lampada da terra realizzata in ottone dotata di una parabola orientabile. Sorgente LED integrata e dimmer a pedale incluso. Disponibile in nero opaco, ottone lucido e bronzo verniciato.

—
Floor lamp made of brass with adjustable shade. Embedded LED lighting source and pedal dimmer included. Available in matte black, polished brass and painted bronze.

—
Lampadaire en laiton équipé d'un réflecteur sphérique orientable. Source LED intégrée et variateur d'intensité à pédale inclus. Disponible en noir mat, laiton poli et bronze peint.

—
Stehlampe aus Messing mit verstellbarem Lampenschirm. Integrierte LED-Lichtquelle und Pedal-Dimmer. Verfügbar in Mattschwarz, poliertem Messing und lackierter Bronze.

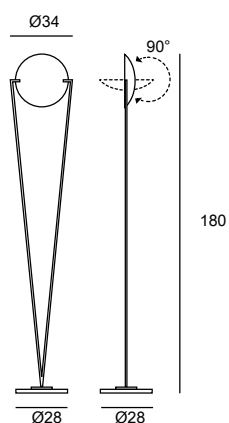

LED 40W 3900lm 3000K CRI>90
Foot Dimmer

CE  Classe I IP20





_ TMB Family

Design LCI.LAB

TRIBUTE TO M. BREUER

Nel 1925 Marcel Breuer progettò la versione da tavolo per l'esposizione universale di Parigi ispirandosi alle linee dell'Art Decò. Lumen Center come tributo al designer ne riedita due versioni: da terra e da tavolo.

TRIBUTE TO M. BREUER

In 1935 Marcel Breuer designed the table version for the Exposition Universelle of Paris, drawing inspiration from the Art Decò lines. As a tribute to the designer, Lumen Center reedited two versions of it: a table and a floor version.

TRIBUTE TO M. BREUER

En 1925, Breuer s'est inspiré des lignes de l'Art déco pour réaliser une version de table de cette lampe destinée à l'Exposition Universelle de Paris. En hommage au grand designer et architecte, Lumen Center en réédite deux versions : le lampadaire et la lampe de table.

TRIBUTE TO M. BREUER

Im Jahr 1935 entwarf Marcel Breuer eine Version als Tischlampe für die Exposition Universelle in Paris, in Anlehnung an die Linien des Art Decò. Als Hommage an den Designer hat Lumen Center zwei Versionen neu aufgelegt: eine Tisch- und eine Bodenversion.

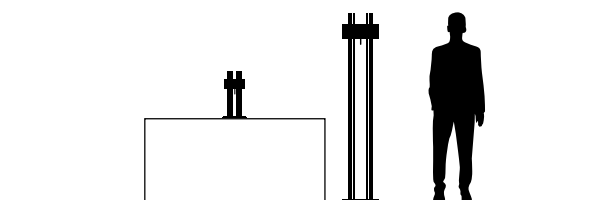

TMB 02
Table lamp



— Lampada da tavolo realizzata in ottone e ferro con sorgente LED integrata e dimmer su corpo lampada. Disponibile in ottone satinato e bronzo verniciato.

— Table lamp made of brass and steel with embedded LED lighting source and dimmer on the lamp's body. Available in satin brass and painted bronze.

— Lampe à poser en laiton et en fer avec source LED intégrée et variateur d'intensité sur le corps de la lampe. Disponible en laiton brossé et en bronze peint.

— Tischlampe aus Messing und Stahl mit doppelter integrierter C auf dem Körper der Lampe. Verfügbar in satiniertem Messing und lackierter Bronze.

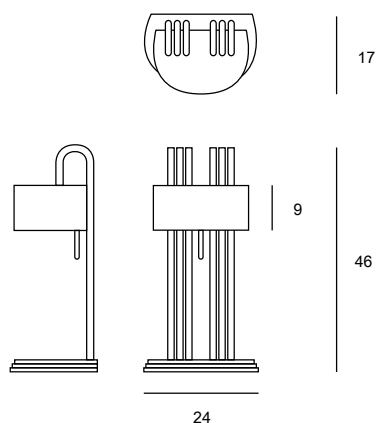

152 Satin Brass
175 Painted Bronze

LED 15W 1200lm 3000K CRI>90
Dimmer integrated on the structure

CE  Classe I IP20



TMB 11
Floor lamp



— Lampada da terra realizzata in ottone e ferro con doppia sorgente LED integrata e dimmer su corpo lampada. Disponibile in ottone satinato e bronzo verniciato.

— Floor lamp made of brass and steel with double embedded LED lighting source and dimmer on the lamp's body. Available in satin brass and painted bronze.

— Lampadaire en laiton et en fer avec double source LED intégrée et variateur d'intensité sur le corps du lampadaire. Disponible en laiton brossé et en bronze peint.

— Stehlampe aus Messing und Stahl mit doppelter integrierter LED-Lichtquelle und Dimmer auf dem Körper der Lampe. Verfügbar in satiniertem Messing und lackierter Bronze.

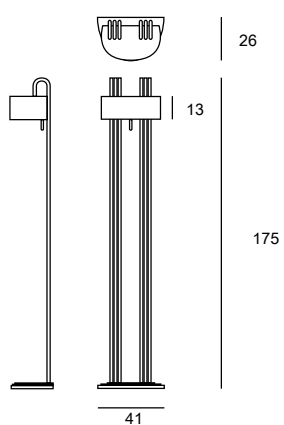

152 Satin Brass
175 Painted Bronze

UP
LED 34W 2900lm 3000K CRI>90
DOWN
LED 15W 1200lm 3000K CRI>90
Dimmer integrated on the structure

CE  Classe I IP20

Unit: cm





Grus

Design A. Saggia e V. Sommella

UNA GRU DI LUCE

Disegnata da Alberto Saggia e Valerio Sommella, Grus prende ispirazione dell'elegante e longilineo volatile in procinto di spiccare il volo. L'esile linearità del corpo si staglia nello spazio, in una perfetta e geometrica armonia.

A CRANE OF LIGHT

Designed by Alberto Saggia and Valerio Sommella, Grus draws inspiration from the elegant and nimble bird about to take flight. The slender lines of its body are exalted in space by perfect, geometric harmony.

UNE GRUE DE LUMIÈRE

Dessinée par Alberto Saggia et Valerio Sommella, Grus s'inspire de l'oiseau élégant et élané sur le point de s'envoler. La mince linéarité du corps se détache dans l'espace, dans une harmonie parfaite et géométrique.

EIN KRANICH AUS LICHT

Entworfen von Alberto Saggia und Valerio Sommella, wurde diese Stehlampe vom eleganten und schlanken Vogel inspiriert. Sie erinnert an die charakteristische Pose des Vogels, bevor er auffliegt. Die schmalen Linien seines Körpers sind im Raum mit perfekter geometrischer Harmonie verherrlicht.

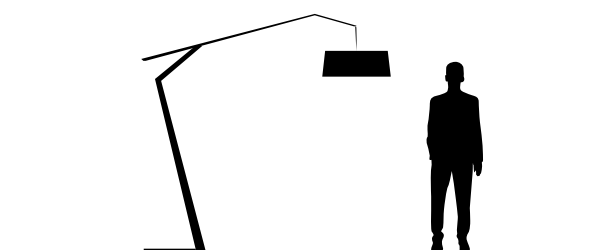





GRUS

Floor lamp



—
Lampada da terra realizzata in metallo verniciato, la cui struttura è divisa in due parti imperniate una sull'altra e tenute in tensione da un cavo metallico che scorre parallelo ad essa. Finitura in nero ft con diffusore in tessuto bianco, rosso vino o verde salvia.

—
Floor lamp made of varnished metal, whose structure is divided into two parts hinged on one another and held by a metallic cable that runs parallel to it. Finish in black ft with diffuser in white, red wine or sage green textile.

—
Lampadaire en métal laqué dont la structure est composée de deux parties articulées l'une sur l'autre maintenues par un câble métallique parallèle à la structure. Finition en noir ft avec diffuseur en tissu blanc, rouge vin ou vert sauge.

—
Stehlampe aus lackiertem Metall, deren Struktur aus zwei Teilen besteht, die aneinander befestigt sind und von einem parallel dazu verlaufenden Metallkabel gehalten werden. Verzierungen in Schwarz ft mit Diffuser in weiß, weinrot oder salbeigrünem Textil.

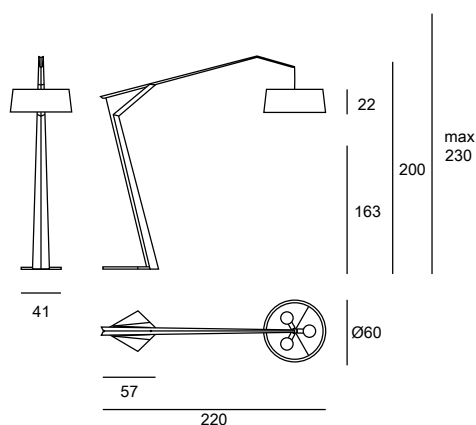

■ 103 Black FT

+

□ BC White

■ R Red wine

■ W Sage

3xE27

Dimmable according to bulb
Foot Dimmer







— Skylines

Design Ahlux

SOTTILI FILI DI LUCI

Come esili fili nel cielo tessono geometrie essenziali. Rimandano alla materia e ai suoi immensi vuoti puntellati di luce. Linee di luce e fili neri, punti di luce e ombre. Skylines è una famiglia di lampade a sospensione e da soffitto composta da sottili tubi metallici intervallati da corpi illuminanti lineari.

THIN THREADS OF LIGHT

Like slender threads in the sky, they weave essential geometries. They refer to matter and its immense voids dotted with light. Lines of light and black threads, points of light and shadows. Skylines is a family of pendant and ceiling lamps composed of thin metal tubes interspersed with linear light fittings.

DE MINCES FILS DE LUMIÈRE

Semblables à des fils graciles dans le ciel, ils semblent tisser des géométries essentielles faisant référence à la matière et à ses vides immenses constellés de lumière. Des lignes de lumière et des fils noirs, des points de lumière et des ombres. La famille Skylines regroupe des suspensions et des plafonniers composées de tubes en métal fins entrecoupés de corps lumineux linéaires.

DÜNNE FÄDEN AUS LICHT

Wie dünne Fäden am Himmel weben sie wesentliche Geometrien. Sie verweisen auf die Materie und ihre unermesslichen, von Licht durchzogenen Leerräume. Linien aus Licht und schwarzen Fäden, Lichtpunkte und Schatten. Skylines ist eine Familie von Pendel- und Deckenlampen, die aus dünnen Metallrohren bestehen, die mit linearen Leuchten durchsetzt sind.

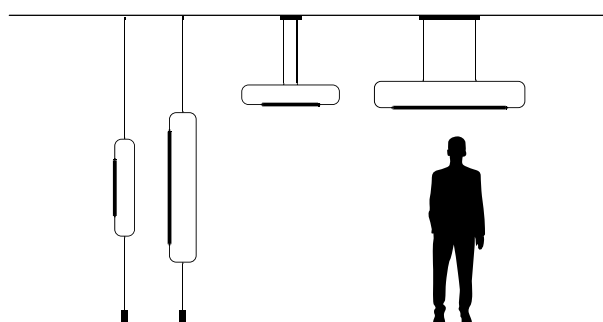

SKYLINES S&P S - M**Ceiling lamp**

—
Lampada da soffitto realizzata in metallo, adattabile a varie altezze e alimentazione cavo e spina, con diffusore in vetro Pyrex lineare a forma di fiore. Sorgente LED integrata e dimmer a pedale Dali incluso. Finitura in nero ft arricchita da dettagli in ottone.

—
Ceiling lamp made of metal, adjustable in different heights and power supply with wire and plug, with flower shaped Pyrex diffuser made of glass. Embedded LED light sources and Dali pedal dimmer. Finishes in black ft with details in brass.

—
Plafonnier en métal, réglable à différentes hauteurs avec alimentation par câble et prise, et diffuseur en verre Pyrex linéaire en forme de fleur. Source LED intégrée et variateur à pédale Dali inclus. Finition en noir ft enrichie des détails en laiton.

—
Deckenleuchte aus Metall, in verschiedenen Höhen verstellbar und mit Stromversorgung mit Kabel und Stachel, mit blumenförmigem Pyrex Diffusor aus Glas. Integrierte LED-Lichtquellen und Dali Pedal Dimmer. Verzierungen in Schwarz mit Details aus Messing.



SKYLINES SUSPENSION S - M**Suspension lamp**

—
Lampada a sospensione realizzata in metallo con diffusore in vetro Pyrex lineare a forma di fiore. Sorgente LED integrata e alimentatore elettronico dimmerabile Dali. Finitura in nero ft arricchita da dettagli in ottone.

—
Suspension lamp made of metal with flower shaped Pyrex diffuser made of glass . Embedded LED light sources and Dali dimmable power supply. Finishes in black ft with details in brass.

—
Suspension en métal avec diffuseur en verre Pyrex linéaire en forme de fleur. Source LED intégrée et variateur Dali. Finition en noir ft enrichie de détails en laiton.

—
Hängeleuchte aus Metall mit blumenförmigem Pyrex-Diffusor aus Glas. Integrierte LED-Lichtquellen und dimmbares Dali Stromversorgung. Verzierungen in schwarz ft mit Details aus Messing.



SKYLINES S&P S

Ceiling lamp

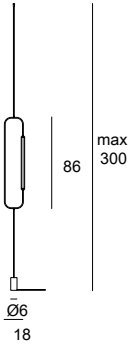

103 Black FT 152 Satin Brass

LED 12W 1560lm 2700K CRI>90
Foot dimmer Dali/Push

CE Classe I IP20

Unit: cm

SKYLINES S&P M

Ceiling lamp

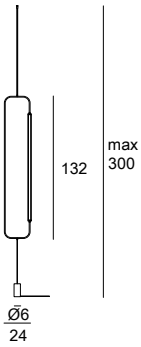

103 Black FT 152 Satin Brass

LED 24W 3120lm 2700K CRI>90
Foot dimmer Dali/Push

CE Classe I IP20

Unit: cm

SKYLINES SUSPENSION S

Suspension lamp

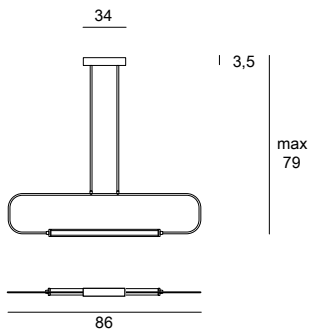

103 Black FT 152 Satin Brass

LED 12W 1560lm 2700K CRI>90
Dimmable Dali/Push

CE Classe I IP20

Unit: cm

SKYLINES SUSPENSION M

Suspension lamp

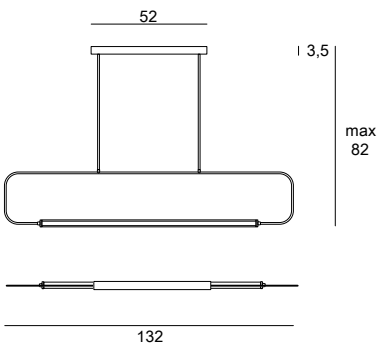

103 Black FT 152 Satin Brass

LED 24W 3120lm 2700K CRI>90
Dimmable Dali/Push

CE Classe I IP20

Unit: cm





— Seaflower

Design Ahlux

FIORE RESILIENTE E LUMINOSO

Come un fiore proteso dall'acqua verso l'alto, sottile, resiliente, dona il suo splendore agli oggetti della nostra memoria.

RESILIENT AND BRIGHT FLOWER

Like a flower reaching upwards from the water, subtle, resilient, it lends its radiance to the objects of our memory.

FLEUR RÉSILIENTE ET LUMINEUSE

Telle une fleur sortant de l'eau, fine et résiliente, elle confère toute sa splendeur aux objets de notre mémoire.

UNVERWÜSTLICHE UND LEUCHTENDE BLUME

Wie eine Blume, die sich aus dem Wasser erhebt, zart und unverwüstlich, verleiht sie den Objekten unserer Erinnerung ihr Strahlen.

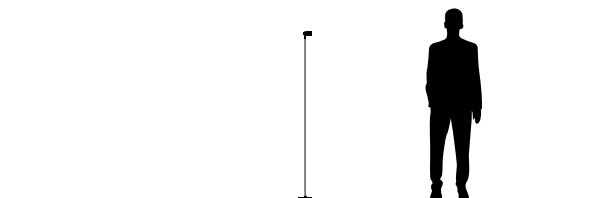

SEAFLOWER

Floor lamp



—
Lampada da terra in metallo, il suo spot LED è orientabile in verticale grazie a uno snodo integrato fino a 45° verso il basso e 90° verso l'alto. Sorgente LED integrata e dimmer a pedale incluso. Finitura in nero ft con doppia base in metallo e in marmo Verde Alpi.

—
Floor lamp made of metal. Thanks to an integrated joint adjustable up to 45 ° downwards and 90° upwards, the LED spot can be swiveled vertically. Embedded LED light sources and pedal dimmer on lamp's body. Finishes in black ft with double base in metal and Verde Alpi marble.

—
Lampadaire en métal dont le spot LED peut être orienté verticalement grâce à sa rotule intégrée jusqu'à 45° vers le bas et 90° vers le haut. Source LED intégrée et variateur d'intensité à pédale inclus. Finition en noir ft avec double socle en métal et marbre Vert des Alpes.

—
Stehlampe aus Metall. Dank eines integrierten Gelenks, das bis zu 45° nach unten und 90° nach oben verstellbar ist, kann der LED-Spot vertikal geschwenkt werden. Integrierte LED-Lichtquellen und Pedal Dimmer am Lampenkörper. Verzierungen in schwarz ft mit Doppelgrund aus Metall und Verde Alpi Marmor.

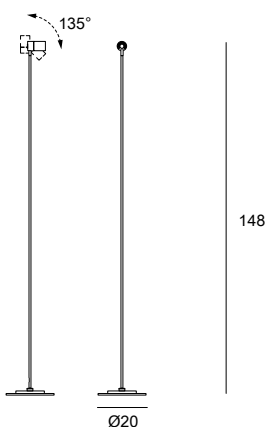

■ 103 Black FT ■ V Verde Alpi

LED 11W 1000lm 2700K CRI>97
BEAM ANGLE: 56°
ON-OFF on cable

CE   lum RoHSIP20

Unit: cm





— Luxsi Collection

Design Ahlux

UN CORAZZIERE LUMINOSO

Come un corazziere alla guardia, alto e di presenza. Trae dal sole ispirazione per la sua luce armoniosa, equilibrata e naturale.

A BRIGHT ARMOURER

As a cuirassier on guard, present and tall. It draws inspiration from the sun for its harmonious, balanced and natural light.

UN CUIRASSIER LUMINEUX

Rappelant un cuirassier grand et de belle prestance montant la garde, Luxsi s'inspire du soleil pour sa lumière harmonieuse, équilibrée et naturelle.

EIN STRAHLENDER WAFFENSCHMIED

Wie ein Kürassier auf der Wache, präsent und groß. Das harmonische, ausgewogene und natürliche Licht ist von der Sonne inspiriert.

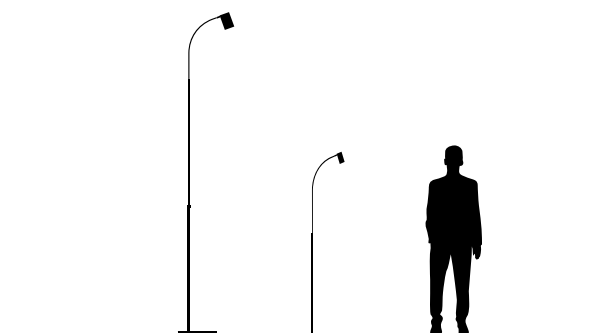

LUXSI 09
Floor lamp



—
Lampada da lettura realizzata in metallo con asta verticale leggermente ricurva sulla sommità. Grazie a uno snodo integrato lo spot LED è orientabile in verticale. Sorgente LED integrata e dimmer a pedale incluso. Disponibile in nero ft e bianco ft.

—
Reading lamp made of metal with vertical arm slightly curved at the top. Thanks to an integrated joint, the LED spot can be swiveled vertically. Embedded LED light sources and pedal dimmer included. Available in black ft and white ft.

—
Lampe de lecture en métal avec une tige verticale légèrement courbée au sommet. Grâce à une rotule intégrée, le spot LED peut être orienté à la verticale. Source LED intégrée et variateur à pédale inclus. Disponible en noir ft et en blanc ft.

—
Leselampe aus Metall mit vertikalem, oben leicht gebogenem Arm. Dank eines integrierten Gelenks kann der LED-Spot vertikal geschwenkt werden. Integrierte LED-Lichtquellen und Pedal-Dimmer. Verfügbar in schwarz ft und weiß ft.

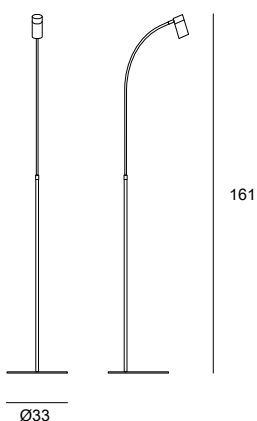

■ 103 Black FT
□ 105 White FT

LED 15W 1400lm 2700K CRI>97
BEAM ANGLE : 50 °
Foot dimmer

CE   lum RoHSIP20



LUXSI 11

Floor lamp



—
Lampada da terra realizzata in metallo e marmo con asta telescopica verticale leggermente ricurva sulla sommità. Grazie a uno snodo integrato lo spot LED è orientabile in verticale. Sorgente LED integrata e dimmer a pedale incluso. Disponibile in nero ft e bianco ft, essa poggia su una doppia base circolare in metallo e in marmo di bianco di Carrara.

—
Floor lamp made of metal and marble with telescopic pole slightly curved at the top. Thanks to an integrated joint, the LED spot can be swiveled vertically. Embedded LED light sources and pedal dimmer included. Available in black ft and white ft. It stands on a double circular base in metal and white Carrara marble.

—
Lampadaire en métal et en marbre avec une tige verticale légèrement courbée au sommet. Grâce à une rotule intégrée, le spot LED peut être orienté à la verticale. Source LED intégrée et variateur à pédale inclus. Disponible en noir ft et en blanc ft, la lampe repose sur une double base circulaire en métal et en marbre blanc de Carrare.

—
Stehlampe aus Metall und Marmor mit oben leicht gebogener Teleskopstange. Dank eines integrierten Gelenks kann der LED-Strahler vertikal geschwenkt werden. Integrierte LED-Lichtquellen und Pedal-Dimmer inklusive. Verfügbar in schwarz ft und weiß ft. Sie steht auf einem doppelten runden Grund aus Metall und weißem Carrara-Marmor.

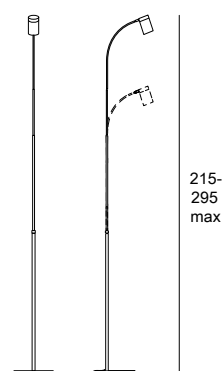

Ø41,5

■ 103 Black FT □ B White Carrara Marble
□ 105 White FT □ B White Carrara Marble

LED 35W 3300lm 2700K CRI>97
BEAM ANGLE : 45°
Foot dimmer

CE lum RoHSIP20

Unit: cm



_ Chiocciola Family







_ Chiocciola Family

Design Ahlux

EQUILIBRIO NATURALE

Chiocciola si presenta come una collezione di oggetti silenziosi, dove protagonista è la luce, diretta e orientabile. La sua leggerezza incontra la solidità di materiali nobili come il legno e il marmo in una sintesi di stasi e movimento.

NATURAL BALANCE

Chiocciola is a collection of silent objects, where the protagonist is the direct, adjustable light. Its lightness blends with the solidity of the fine materials like wood and marble in a synthesis of stasis and movement.

ÉQUILIBRE NATUREL

Chiocciola se présente comme une collection d'objets silencieux, dont la protagoniste est la lumière, directe et orientable. Dans une synthèse entre fixité et mouvement, sa légèreté côtoie la solidité de matériaux nobles tels que le bois et le marbre.

NATÜRLICHES GLEICHGEWICHT

Chiocciola ist eine Kollektion von stillen Objekten, deren Protagonist das direkte, regulierbare Licht ist. Seine Leichtigkeit verschmilzt mit der Solidität der edlen Materialien wie Holz und Marmor zu einer Synthese aus Stillstand und Bewegung.

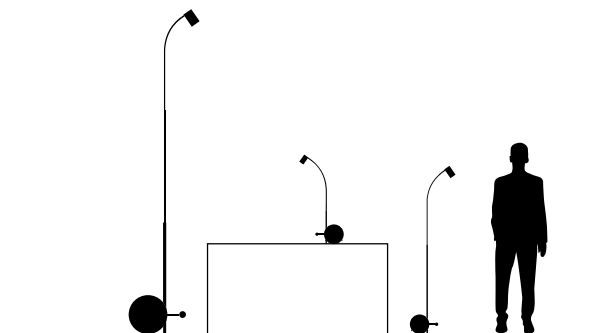

CHIOCCIOLA 02**Table lamp**

–
Lampada da tavolo realizzata in metallo e legno con inclinazione regolabile grazie a una chiavetta posta sulla base. Grazie a uno snodo integrato lo spot LED è orientabile in verticale. Sorgente LED integrata e push dimmer su cavo incluso. Disponibile in nero ft e bianco ft e base circolare in legno di noce canaletto.

–
Table lamp made of metal and wood, adjustable thanks to a key on its base. The integrated joint allows the LED spot to be swiveled vertically. Embedded LED light sources and push dimmer on cable. Available in black ft and white ft with circular base made of canaletto walnut wood.

–
Lampe à poser en métal et en bois dont l'inclinaison est réglable grâce à une clé située sur le socle. Une rotule intégrée permet d'orienter le spot LED à la verticale. Source LED intégrée et variateur avec bouton poussoir sur câble inclus. Disponible en noir ft, blanc ft et base circulaire en bois de noyer noir d'Amérique.

–
Tischlampe aus Metal und Holz regulierbar dank verstellbar dank eines Schlüssels am Sockel. Durch das integrierte Gelenk kann der LED-Spot vertikal geschwenkt werden. Integrierte LED-Lichtquellen und push Dimmer am Kabel. Verfügbar in schwarz ft und weiß ft mit rundem Sockel aus Canaletto-Nussbaumholz.



CHIOCCIOLA 09**Floor lamp**

–
Lampada da lettura realizzata in metallo e legno con inclinazione regolabile grazie a una chiavetta posta sulla base. Lo spot LED è orientabile in verticale grazie a uno snodo integrato. Sorgente LED integrata e dimmer a pedale incluso. Disponibile in nero ft e bianco ft e base circolare in legno di noce canaletto.

–
Reading lamp made of metal and wood, adjustable thanks to a key on its base. The LED spot can be swivelled vertically thanks to an integrated joint. Embedded LED light sources and pedal dimmer included. Available in black ft and white ft with circular base made of canaletto walnut wood.

–
Lampe de lecture en métal et en bois dont l'inclinaison est réglable grâce à une clé située sur le socle. Une rotule intégrée permet d'orienter le spot LED à la verticale. Source LED intégrée et variateur avec bouton poussoir sur câble inclus. Disponible en noir ft, blanc ft et base circulaire en bois de noyer noir d'Amérique.

–
Leselampe aus Metall und Holz, verstellbar dank eines Schlüssels am Sockel. Der LED-Spot kann dank eines integrierten Gelenks vertikal geschwenkt werden. Integrierte LED-Lichtquellen und Pedal-Dimmer. Verfügbar in schwarz ft und weiß ft mit rundem Sockel aus Canaletto-Nussbaumholz.



CHIOCCIOLA 11**Floor lamp**

—
Lampada da terra realizzata in metallo, legno e marmo ha un'asta telescopica con un'inclinazione regolabile per mezzo di una chiavetta posta sulla base. Grazie a uno snodo integrato lo spot LED è orientabile in verticale. Sorgente LED integrata e dimmer a pedale incluso. Disponibile in nero ft e bianco ft con base circolare in legno di noce canaletto e ruote in marmo bianco di Carrara.

—
Floor lamp made of metal, wood, and marble with a telescopic rod with an adjustable inclination through a key on the base. Thanks to an integrated joint, the LED spot can be swiveled vertically. Embedded LED light sources and pedal dimmer included. Available in black ft and white ft with circular base made of canaletto walnut wood and wheels of Carrara white marble.

—
Lampadaire en métal, en bois et en marbre avec un bras télescopique dont l'inclinaison est réglable grâce à une clé située sur le socle. Une rotule intégrée permet d'orienter le spot LED à la verticale. Source LED intégrée et variateur à pédale inclus. Disponible en noir ft, blanc ft avec base circulaire en bois de noyer noir d'Amérique et roues en marbre blanc de Carrare.

—
Stehlampe aus Metall, Holz und Marmor mit einer Teleskopstange, deren Neigung mit Hilfe eines Schlüssels am Sockel verstellbar ist. Dank eines integrierten Gelenks kann der LED-Spot vertikal geschwenkt werden. Integrierte LED-Lichtquellen und Pedal-Dimmer inklusive. Verfügbar in schwarz ft und weiß ft mit rundem Sockel aus Canaletto-Nussbaumholz.



CHIOCCIOLA 02

Table lamp

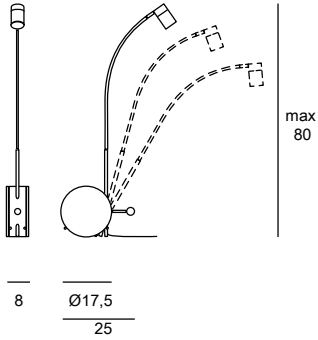

103 Black FT LN Walnut
105 White FT LN Walnut

LED 11W 1000lm 2700K CRI>97
BEAM ANGLE : 56°
Push dimmer on cable

CE lum RoHS IP20

Unit: cm

CHIOCCIOLA 09

Floor lamp

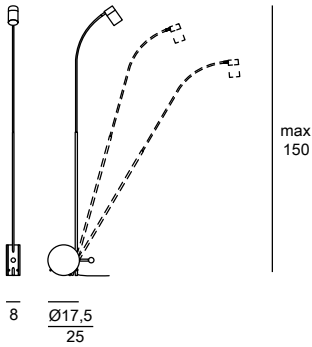

103 Black FT LN Walnut
105 White FT LN Walnut

LED 15W 1400lm 2700K CRI>97
BEAM ANGLE : 50°
Foot dimmer

CE lum RoHS IP20

Unit: cm

CHIOCCIOLA 11

Floor lamp

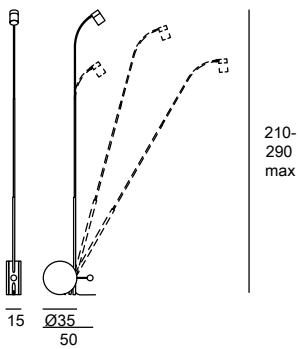

103 Black FT B White Carrara Marble LN Walnut
105 White FT B White Carrara Marble LN Walnut

LED 35W 3300lm 2700K CRI>97
BEAM ANGLE : 45°
Foot dimmer

CE lum RoHS IP20

Unit: cm



Photo By Emma Onesti @ NH Hotel Milano



_ Kiron

Design Ahlux

UN FEDELE CENTAURO DI LUCE

L'antico cavallo da sempre dedito e fedele all'umano spirito, porta su di sé con delicata forza la luce. Protendersi e mai sottrarsi al servizio umile e costante di una migliore cura della persona.

A LOYAL CENTAUR OF LIGHT

The ancient horse that has always been dedicated and faithful to the human spirit, carries light with delicate strength. Strive and never shirk from the humble and constant service of better personal care.

UN FIDÈLE CENTAURE DE LUMIÈRE

Le cheval antique, depuis toujours dévoué et fidèle à l'esprit humain, porte sur lui la lumière avec une force délicate. Tendre la main sans jamais se soustraire à l'humble et constant service d'une meilleure prise en charge personnelle.

EIN TREUER ZENTAUR DES LICHTS

Das uralte Pferd, das dem menschlichen Geist seit jeher treu ergeben ist, trägt das Licht mit zarter Kraft. Bemühen Sie sich und scheuen Sie sich nicht vor dem bescheidenen und ständigen Dienst einer besseren Körperpflege.

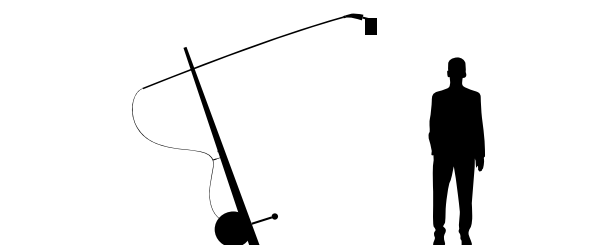

KIRON

Floor lamp



—
Lampada da terra con una struttura in legno ancorata a due ruote in marmo ed un'asta in metallo. Lo spot LED è orientabile in inclinazione ed estensione grazie alle tre possibili posizioni dell'asta ricurva. Sorgente LED integrata e push dimmer su corpo lampada. Finitura in nero ft, con struttura in legno di rovere e ruote in marmo bianco di Carrara.

—
Floor lamp with a wooden frame anchored to two marble wheels and a metal rod. LED spot with adjustable inclination and extension thanks to the three possible positions of the curved arm. Embedded LED light sources and push dimmer on lamp's body. Finishes in black ft, with structure in oak wood and wheels in white Carrara marble.

—
Lampadaire avec une structure en bois fixée sur deux roues en marbre, et une tige en métal. L'inclinaison et l'extension du spot LED peuvent se régler grâce aux trois positions possibles de la tige courbée. Source LED intégrée et variateur avec bouton poussoir sur le corps du lampadaire. Finition en noir ft, avec structure en bois de chêne et roues en marbre blanc de Carrare.

—
Stehlampe mit einem Holzrahmen, der auf zwei Marmorrädern und einer Metallstange verankert ist. LED-Spot mit einstellbarer Neigung und Ausdehnung dank der drei möglichen Positionen des gebogenen Arms. Integrierte LED-Lichtquellen und push Dimmer am Lampenkörper. Verzierungen in schwarz ft, mit Struktur aus Eichenholz und Rädern aus weißem Carrara Marmor.

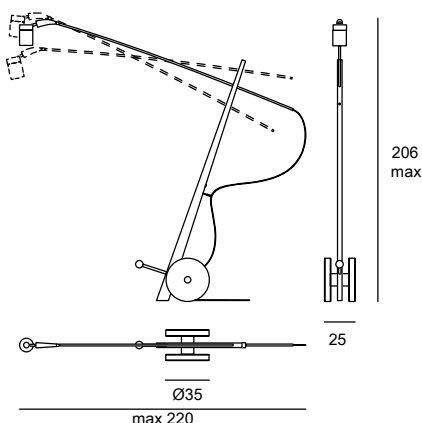

■ 103 Black FT □ B White Carrara Marble ▣ LR Oak

LED 30W 2900lm 2700K CRI>97
BEAM ANGLE : 45°
Push dimmer on the structure

CE lum RoHSIP20

Unit: cm



_ Astolfo Collection







LESLIE WHITE

DIEGO UCHEITEL PORTLAND

KINFOLK

KI

PAUL SIETSEM PAUL SIETSEM

STYLISH NEPPEN STYLE

KONSTEN H.W. JANSON

At Home in Joshua Tree

JOHNGRISHAM

AVEDON advertising

THIS IS HOME

England United Kingdom

MARCEL PROOST LES PLAINES LES JOTTES

— Astolfo Collection

Design A. G. Cavalchini

IL TRIONFO DEL CAVALIERE

Disegnata dall'architetto Amedeo G. Cavalchini, reincarna l'ancestrale epica cavalleresca. La materialità del legno incontra il minimalismo della sorgente luminosa che la attraversa come una lancia di luce.

THE TRIUMPH OF CHIVALRY

Designed from the architect Amadeo G. Cavalchini, it reincarnates the ancestral epic of chivalry. The materiality of wood meets the minimalism of the light source that passes through it like a lance of light.

LE TRIOMPHE DU CHEVALIER

Dessiné par l'architecte Amedeo G. Cavalchini, ce lampadaire réincarne l'épopée ancestrale de la chevalerie. La matérialité du bois rencontre le minimalisme de la source lumineuse qui le traverse comme une lance lumineuse.

DER TRIUMPH DES KAVALIERS

Entworfen vom Architekt Amadeo G. Cavalchini, verkörpert sie das uralte Ritterepos. Die Materialität des Holzes trifft auf den Minimalismus der Lichtquelle, die es wie eine Lichtlanze durchdringt.

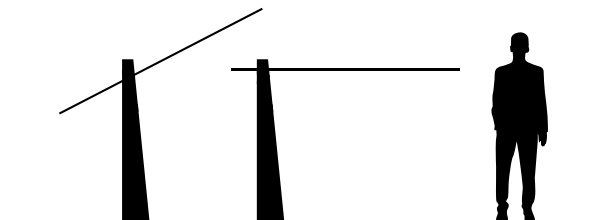



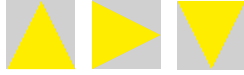

Photo By Emma Onesti @ NH Hotel Milano



ASTOLFO

Floor lamp



—
Lampada da terra con base in legno massello di noce e asta in alluminio anodizzato nero orientabile in 3 diverse angolazioni. Le due sorgenti LED dimmerabili sono collocate lungo l'asta e sul retro della base per un'illuminazione diretta ed indiretta.

—
Floor lamp with base made of solid walnut and black anodized aluminium arm, that can be adjusted in 3 different angles . The two LED lighting sources are dimmable and located along the arm and on the back of the base, allowing for direct and indirect light.

—
Lampadaire avec une structure en noyer massif et une tige en aluminium anodisé noir qui peut être positionné sous 3 angles différents. Les deux sources LED à intensité variable sont disposées le long du bras et à l'arrière de la base pour un éclairage direct et indirect.

—
Stehlampe mit Grund aus Walnuss-Holzbasis und Stab aus schwarzem eloxiertem Messing, der in 3 verschiedenen Winkeln einstellbar ist. Die zwei LED-Lichtquellen mit Dimmer befinden sich entlang des Arms und hinter dem Grund. Das ermöglicht sowohl eine direkte als auch eine indirekte Beleuchtung.

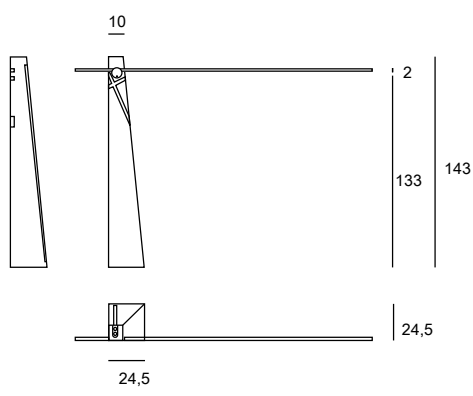

■ LN Walnut ■ 174 Black anodized aluminum

ARM:
LED 36W 3240lm 3000K CRI>90
BACK:
LED 24W 2160lm 3000K CRI>90
Push dimmer on the structure

CE IP20



ASTOLFO HT
Floor lamp



—
 Lampada da terra con base in acciaio verniciato e fronte in massello di rovere e asta in alluminio anodizzato nero, orientabile in 3 diverse angolazioni. La sorgente LED dimmerabile è collocata lungo l'asta.

—
 Floor lamp with base made of varnished steel and front in solid oak and black anodized aluminium arm, that can be adjusted in 3 different angles. The LED lighting source is dimmable and located along the arm.

—
 Lampadaire avec base en acier peint et façade en chêne massif et tige en aluminium anodisé noir, qui peut être positionnée sous 3 angles différents. La source LED à intensité variable est positionnée le long de la tige.

—
 Stehlampe mit lackiertem Grund aus Stahl und mit einer Frontseite aus Volleichenholz und Stab schwarzem eloxiertem Messing, der in 3 verschiedenen Winkeln einstellbar ist. Die LED-Lichtquelle mit Dimmer befindet sich entlang des Arms.

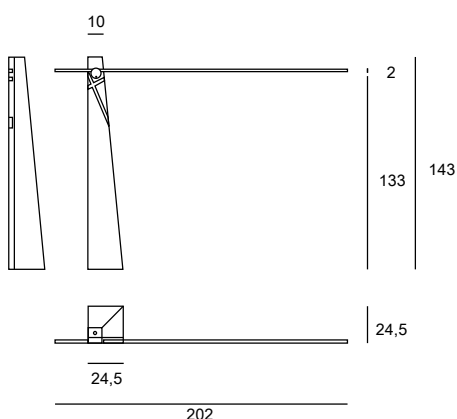

■ LR Oak ■ 174 Black anodized aluminum

ARM:
 LED 36W 3240lm 3000K CRI>90
 Push dimmer on the structure

CE IP20



_ Morgana & Sibylla Collection

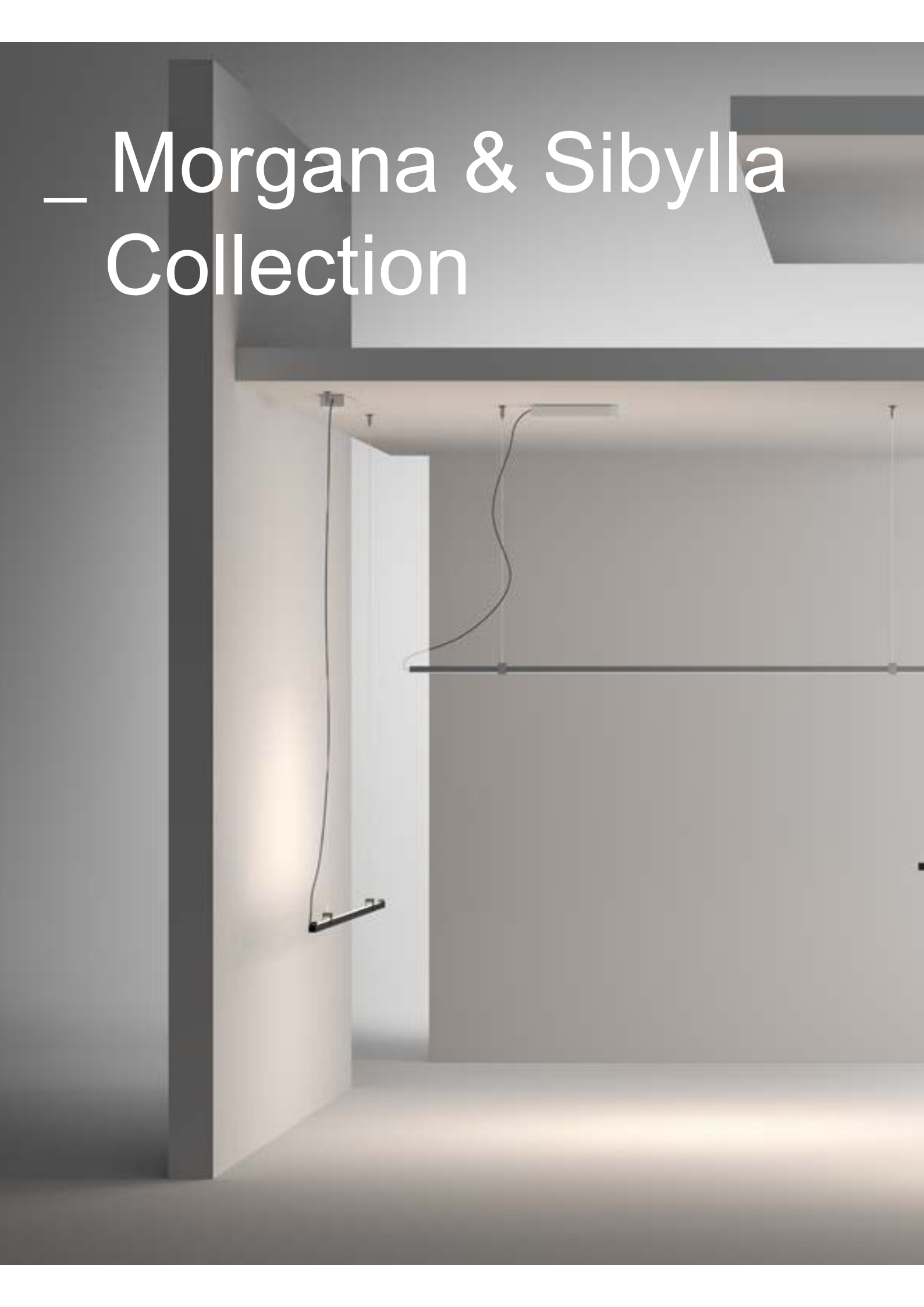

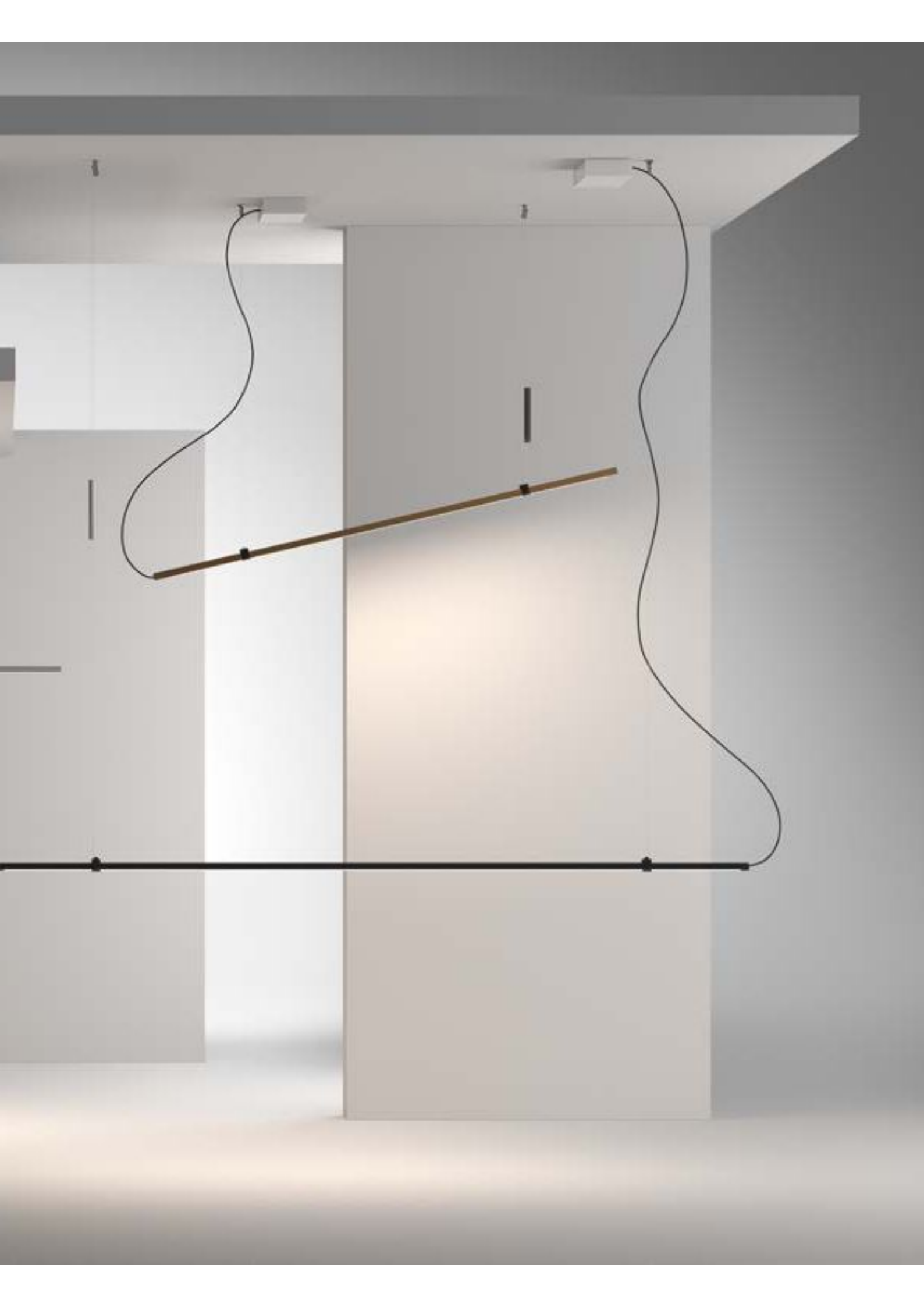



_ Morgana & Sibylla

Design A. G. Cavalchini

DINAMICHE LINEE DI LUCE

Disegnate da Amedeo G. Cavalchini, Morgana e Sibylla sono lampade dal profilo leggero e sottile pensate per essere essenziali e dinamiche sia nella forma che nella luce.

DYNAMIC LINES OF LIGHT

Designed by Amedeo G. Cavalchini, Morgana and Sibylla present a light and slim profile, which is projected to be essential and dynamic both in form and in emitted light.

LIGNES DE LUMIÈRE DYNAMIQUES

Dessinées par Amedeo G. Cavalchini, les suspensions Morgana et Sibylla au profil léger et mince, sont conçues pour être essentielles et dynamiques, tant au niveau de la forme que de la lumière.

DYNAMISCHE LINIEN AUS LICHT

Entworfen von Amedeo G. Cavalchini, präsentieren Morgana and Sibylla ein leichtes und schlankes Profil, das sowohl in der Form als auch im ausgestrahlten Licht wesentlich und dynamisch sein soll.

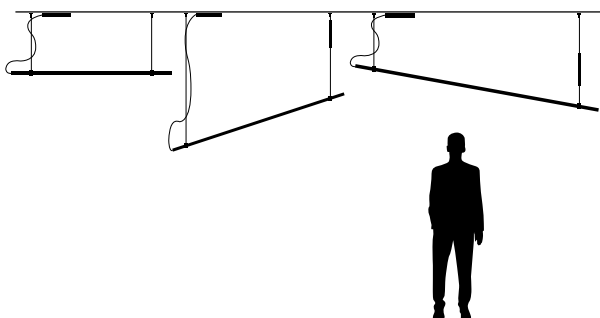

MORGANA S-M-L**Suspension lamp**

– Lampada a sospensione realizzata in alluminio estruso e disponibile in 3 lunghezze. Sorgente LED integrata ed alimentatore dimmerabile TRIAC. Grazie alle clip in dotazione è possibile orientare il fascio luminoso sia verso l'alto che verso il basso. Disponibile in alluminio anodizzato naturale, alluminio anodizzato nero e oro champagne.

– Suspension lamp made of extruded aluminium and available in 3 lengths. Embedded LED lighting source and TRIAC dimmable power supply. Thanks to the supplied clips, the light beam can be directed upwards or downwards. Available in natural anodized aluminium, black anodized aluminium or gold champagne.

– Suspension en aluminium extrudé disponible en trois longueurs. Source LED intégrée et driver dimmable TRIAC. Le faisceau lumineux peut être orienté vers le haut ou vers le bas grâce aux clips fournis. Disponible en aluminium anodisé naturel, aluminium anodisé noir et or champagne.

– Hängelampe aus extrudiertem Aluminium und verfügbar in 3 Längen. Integrierte LED-Lichtquelle und dimmbare TRIAC Stromversorgung inkludiert. Dank der enthaltenen Clips kann der Lichtstrahl nach oben oder nach unten gerichtet werden. Verfügbar in natureloxiertem Aluminium, schwarz eloxiertem Aluminium oder goldchampagner.





SIBYLLA S-M-L**Suspension lamp**

– Upgrade della lampada a sospensione Morgana, Sibylla è regolabile in altezza grazie al suo sistema sali-scendi. Intensità e tonalità luminosa regolabili tramite dispositivo Bluetooth integrato. Disponibile in alluminio anodizzato naturale, alluminio anodizzato nero e oro champagne.

– Upgrade of the suspension lamp Morgana, Sybilla has adjustable length enabled by its up-down system. Intensity and colour temperature can be adjusted through an embedded Bluetooth device. Available in natural anodized aluminium, black anodized aluminium or gold champagne.

– Amélioration de la suspension Morgana, Sibylla se règle en hauteur grâce à son système coulissant. Un dispositif Bluetooth intégré permet de régler l'intensité et la nuance de la lumière. Disponible en aluminium anodisé naturel, aluminium anodisé noir et or champagne.

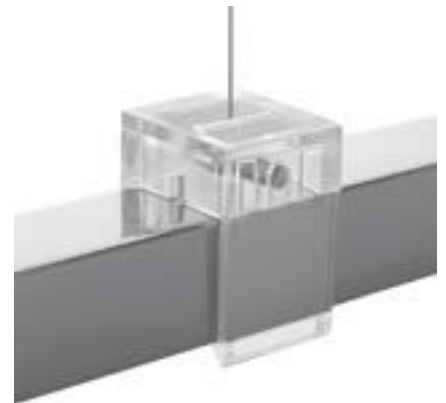

– Sybilla ist eine Weiterentwicklung der Hängelampe Morgana und kann durch ihr Up-Down-System in der Länge verstellt werden. Intensität und Farbtemperatur können über ein integriertes Bluetooth-Gerät eingestellt werden. Verfügbar in natureloxiertem Aluminium, schwarz eloxiertem Aluminium oder goldchampagner.



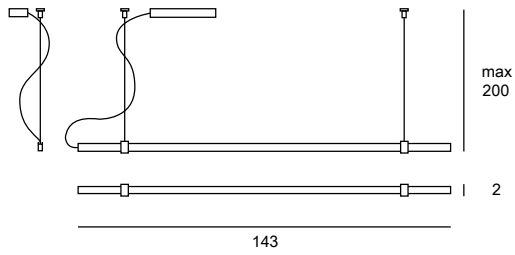

MORGANA S Suspension



-  172 Natural Anodized aluminium
-  174 Black Anodized aluminium
-  177 Champagne Gold

Clips: black or transparent



LED 28W 3360lm 2700K or 3000K CRI>90
Dimmable TRIAC

  Classe IIP20

Unit: cm

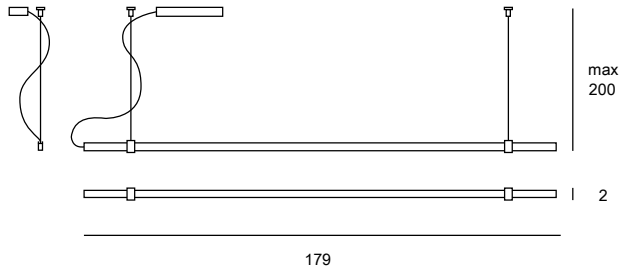
MORGANA M Suspension



-  172 Natural Anodized aluminium
-  174 Black Anodized aluminium
-  177 Champagne Gold

Clips: black or transparent



LED 34W 4080lm 2700K or 3000K CRI>90
Dimmable TRIAC

  Classe IIP20

Unit: cm

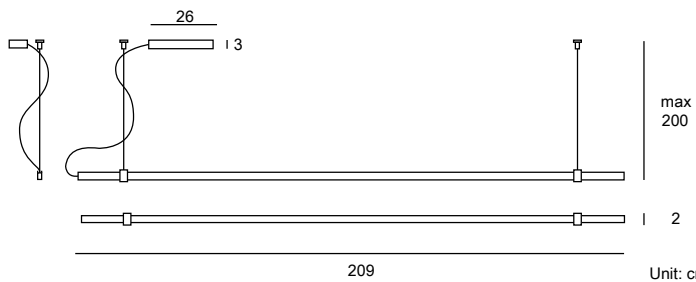
MORGANA L Suspension



-  172 Natural Anodized aluminium
-  174 Black Anodized aluminium
-  177 Champagne Gold

Clips: black or transparent

LED 40W 4800lm 2700K or 3000K CRI>90
Dimmable TRIAC

  Classe IIP20

Unit: cm

**SIBYLLA S
Suspension**

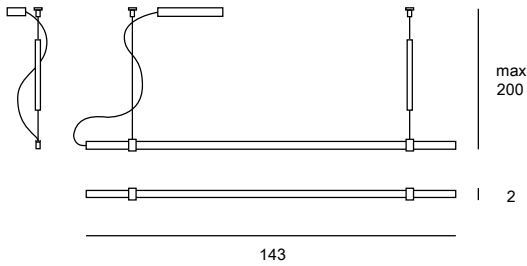

- 172 Natural Anodized aluminium
- 174 Black Anodized aluminium
- 177 Champagne Gold
- + counterweight
- 103 Black FT
- 150 Chrome

Clips: black or trasparent

LED Dinamic White Control DWC 24W 3360lm 2700K - 6300K
CRI>90
Bluetooth Control with application for Android and iOS systems



Unit: cm

**SIBYLLA M
Suspension**

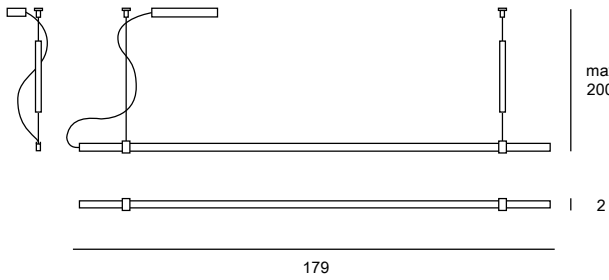

- 172 Natural Anodized aluminium
- 174 Black Anodized aluminium
- 177 Champagne Gold
- + counterweight
- 103 Black FT
- 150 Chrome

Clips: black or trasparent

LED Dinamic White Control DWC 30W 4080lm 2700K - 6300K
CRI>90
Bluetooth Control with application for Android and iOS systems



Unit: cm

**SIBYLLA L
Suspension**

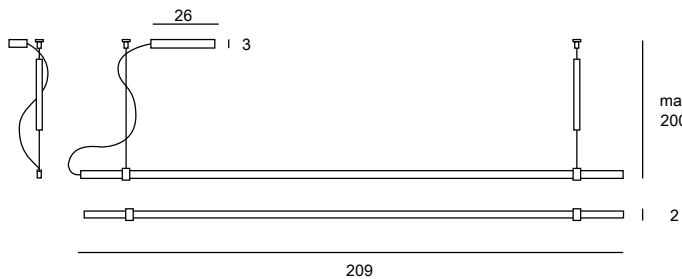

- 172 Natural Anodized aluminium
- 174 Black Anodized aluminium
- 177 Champagne Gold
- + counterweight
- 103 Black FT
- 150 Chrome

Clips: black or trasparent

LED Dinamic White Control DWC 36W 4800lm 2700K - 6300K
CRI>90
Bluetooth Control with application for Android and iOS systems



Unit: cm

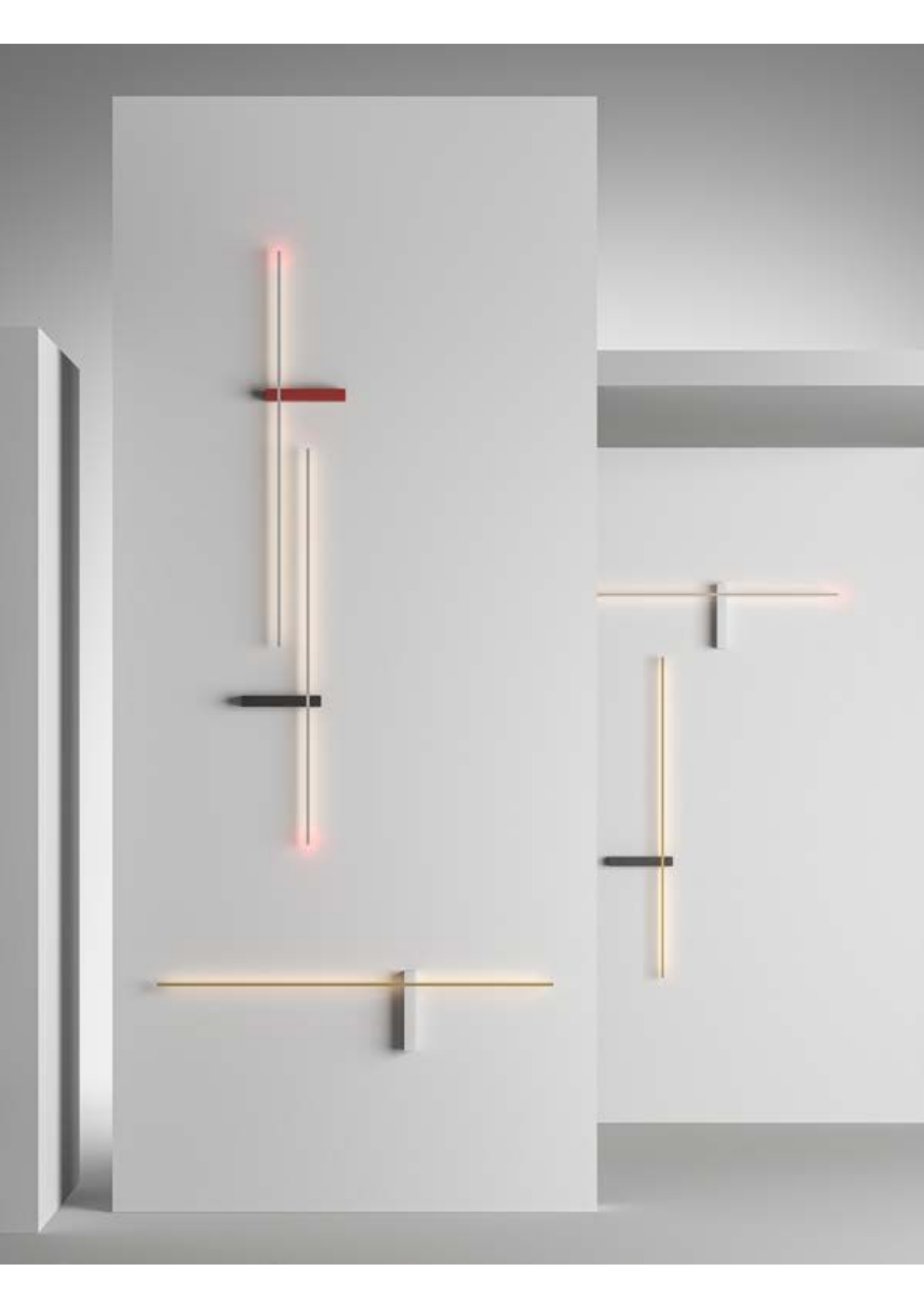

— Outline

Design F. Murano

GRAFISMI DI LUCE

Disegnata dall'architetto Francesco Murano, Outline è una sottile applique dove la sua luce indiretta vuole ricordare la silhouette di un fiammifero. Luce e struttura si uniscono creando un affresco luministico tracciato nello spazio.

GRAPHISMS OF LIGHT

Designed by architect Francesco Murano, Outline is a slender wall lamp, whose indirect light recalls the silhouette of a matchstick. Light and structure blend to become a luminist fresco that cuts through space.

GRAPHISMES DE LUMIÈRE

Dessinée par l'architecte Francesco Murano, Outline est une fine applique murale qui projette une lumière indirecte évoquant la silhouette d'une allumette. Lumière et structure s'associent pour former une fresque lumineuse dans l'espace.

GRAPHISMUS AUS LICHT

Entworfen vom Architekt Francesco Murano, ist Outline eine schmale Wandlampe, deren indirektes Licht an die Silhouette eines Streichholzes erinnert. Licht und Struktur verschmelzen zu einem luministischen Fresko, das den Raum durchschneidet.

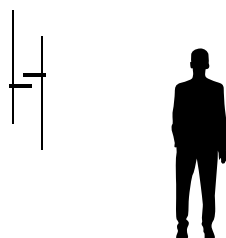





OUTLINE**Wall lamp**

—
Lampada da parete realizzata in alluminio è disponibile nelle versioni “Total White” e “Red Light”. Sorgente LED integrata e alimentatore elettronico ON-OFF. Disponibile in alluminio anodizzato naturale e oro champagne con basetta in nero ft, bianco ft e red brown ft.

—
Wall lamp made of aluminium and available in the “Total White” and “Red Light” versions. Embedded LED lighting source and ON-OFF power supply. Available in aluminium anodized natural and champagne gold with base in black ft, white ft and red brown ft.

—
Cette applique murale en aluminium est disponible en version ‘Total White’ et ‘Red Light’. Source LED intégrée et alimentation électronique ON-OFF. Disponible en aluminium anodisé naturel et or champagne avec base en noir ft, blanc ft et red brown ft.

—
Wandlampe aus Aluminium und verfügbar in den Versionen “Total White” und “Red Light”. Integrierte LED-Lichtquelle und ON-OFF Stromversorgung. Verfügbar in natureloxiertem Aluminium und schwarz und goldchampagner mit Verzierungen in schwarz ft, weiß ft und rotbraun ft.

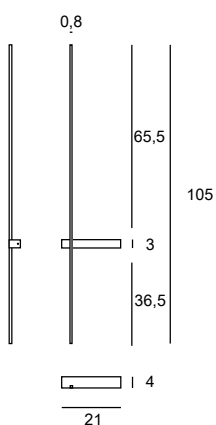

	103 Black FT
	105 White FT
	138 Red Brown FT
+	
	172 Natural Anodized aluminium
	177 Champagne Gold

LED 12W+1W Red 1560lm 3000K CRI>90
LED 12W Total White 1560lm 3000K CRI>90
ON-OFF

Classe I IP20



_ Flat Collection







HOKUSAI



_ Flat Collection

Design VillaTosca

FOGLI DI LUCE

Sottile ed elegante come un foglio luminoso, Flat condensa in 8 mm lo spessore del corpo lampada. La luce emessa risulta diretta verso il basso e al contempo verso l'alto, grazie ai tagli nella parte superiore.

LAYERS OF LIGHT

Slender and elegant as a layer of light, Flat condenses in 8 mm the surface of the body lamp. The light is directly emitted both downward and upward, thanks to the openings on both top and bottom.

FEUILLES DE LUMIÈRE

Aussi fine et élégante qu'une feuille de lumière, Flat condense en 8 mm l'épaisseur du corps de la lampe. Grâce aux découpes situées sur la partie supérieure, la lumière émise est dirigée à la fois vers le bas et vers le haut.

BLÄTTER AUS LICHT

Schmal und elegant wie ein Blatt aus Licht, kondensiert in 8 mm die Oberfläche der Körperlampe. Sie strahlt direktes Licht sowohl nach oben als auch nach unten dank den Schnitten auf der Oberfläche.

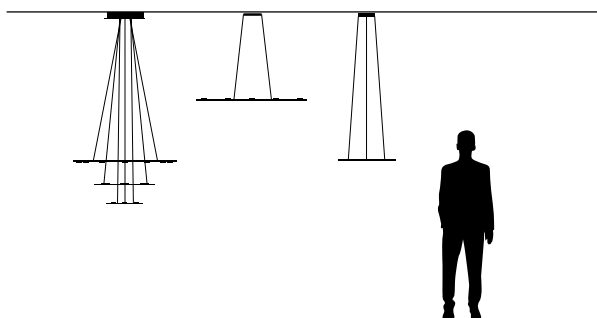

FLAT 04 - 05 - 06**Suspension lamp**

–
Lampada a sospensione realizzata in alluminio a 4, 5 o 6 punti luce disposti linearmente. Sorgenti LED integrate a luce diretta ed indiretta grazie a diffusori lenticolari in policarbonato ed alimentatore elettronico dimmerabile TRIAC. Disponibile in alluminio anodizzato naturale, alluminio anodizzato nero ed oro champagne.

–
Suspension light with 4, 5 or 6 light spots arranged in a line. Embedded LED lighting source with direct and indirect light enabled by polycarbonate lentiform diffusers and TRIAC dimmable electronic power supply. Available in natural anodized aluminium, black anodized aluminium or gold champagne.

–
Suspension en aluminium avec 4, 5 ou 6 points lumineux disposés linéairement. Sources LED intégrées diffusant une lumière indirecte vers le haut et directe vers le bas grâce à des diffuseurs lenticulaires en polycarbonate. Driver dimmable TRIAC. Disponible en aluminium anodisé naturel, aluminium anodisé noir et or champagne.

–
Hängelampe mit 4,5 oder 6 Lichtpunkten im Kreis. Integrierte LED-Lichtquelle mit direktem und indirektem Licht ermöglicht vom linsenförmige Polycarbonat-Diffusoren und TRIAC dimmbare, elektronische Stromversorgung. Verfügbar in natureloxiertem Aluminium, schwarzem oder goldchampagnerfarben eloxiertem Aluminium.



FLAT RING 3 - 6 - 12**Suspension lamp**

–
Lampada a sospensione realizzata in alluminio a 3, 6 o 12 punti luce disposticircularmente. Sorgenti LED integrate a luce diretta ed indiretta grazie a diffusori lenticolari in policarbonato ed alimentatore elettronico dimmerabile TRIAC. Disponibile in alluminio anodizzato naturale, alluminio anodizzato nero ed oro champagne.

–
Suspension lamps with 3, 6, or 12 LED lighting spots arranged in a circle. LED lighting source with direct and indirect light enabled by polycarbonate lentiform diffusers and TRIAC dimmable electronic power supply. Available in natural anodized aluminium, black anodized aluminium or gold champagne.

–
Suspension en aluminium avec 3, 6 ou 12 points lumineux disposés en cercle. Sources LED intégrées diffusant une lumière indirecte vers le haut et directe vers le bas grâce à des diffuseurs lenticulaires en polycarbonate. Driver dimmable TRIAC. Disponible en aluminium anodisé naturel, aluminium anodisé noir et or champagne.

–
Hängelampen mit 3,6 oder 12 LED-Lichtpunkten im Kreis. Integrierte LED-Lichtquelle mit direktem und indirektem Licht ermöglicht vom linsenförmige Polycarbonat-Diffusoren und TRIAC dimmbare, elektronische Stromversorgung. Verfügbar in natureloxiertem Aluminium, schwarzem oder goldchampagnerfarben eloxiertem Aluminium.



FLAT SATURN 1 - 2 - 3**Suspension lamp**

—
Flat Saturn è un sistema di illuminazione che combina i vari modelli di Flat Ring in un'unica sospensione. La lampada è disponibile nelle versioni a due o tre elementi. Sorgenti LED integrate a luce diretta ed indiretta grazie a diffusori lenticolari in policarbonato ed alimentatore elettronico dimmerabile TRIAC. Disponibile in alluminio anodizzato naturale, alluminio anodizzato nero ed oro champagne.

—
Flat Saturn is a lighting system that combines the different Ring models in a single suspension lamp. The lamp is available in a two pieces and a three piece version LED lighting source with direct and indirect light enabled by polycarbonate lentiform diffusers and TRIAC dimmable electronic power supply. Available in natural anodized aluminium, black anodized aluminium or gold champagne.

—
Flat Saturn est un système d'éclairage qui combine les différents modèles Flat Ring en une seule suspension. La lampe est disponible dans les versions à deux et trois éléments. Sources LED intégrées diffusant une lumière indirecte vers le haut et directe vers le bas grâce à des diffuseurs lenticulaires en polycarbonate. Driver dimmable TRIAC. Disponible en aluminium anodisé naturel, aluminium anodisé noir et or champagne.

—
Flat Saturn ist ein Lichtsystem, das die verschiedenen Ring Modelle in einer einzigen Hängelampe kombiniert. Die Lampe ist verfügbar in einer Version aus zwei Stücken und einer aus drei Stücken. Integrierte LED-Lichtquelle mit direktem und indirektem Licht ermöglicht vom linsenförmige Polycarbonat-Diffusoren und TRIAC dimmbare, elektronische Stromversorgung. Verfügbar in natureloxiertem Aluminium, schwarzem eloxiertem Aluminium oder goldchampagnerfarben.





FLAT 04

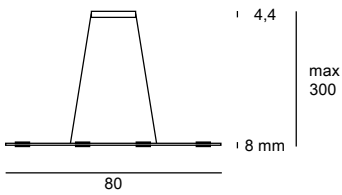

Suspension lamp

Ø16,4



-  172 Natural Anodized aluminium
-  174 Black Anodized aluminium
-  177 Champagne Gold

LED 25,2W 2250lm 2700K CRI>90
LED 25,2W 2500lm 3000K CRI>90
Dimmable TRIAC

  Classe I IP20



Unit: cm

FLAT 05

Suspension lamp

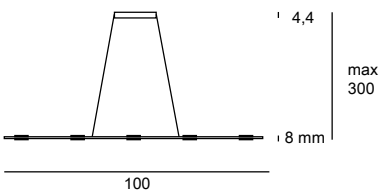
Ø16,4



-  172 Natural Anodized aluminium
-  174 Black Anodized aluminium
-  177 Champagne Gold

LED 31,5W 2850lm 2700K CRI>90
LED 31,5W 3150lm 3000K CRI>90
Dimmable TRIAC

  Classe I IP20



Unit: cm

FLAT 06

Suspension lamp

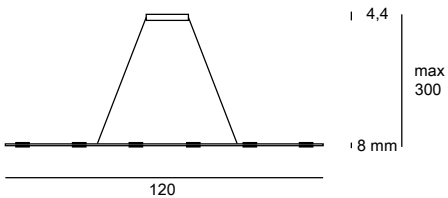
Ø16,4



-  172 Natural Anodized aluminium
-  174 Black Anodized aluminium
-  177 Champagne Gold

LED 37,8W 3420lm 2700K CRI>90
LED 37,8W 3800lm 3000K CRI>90
Dimmable TRIAC

  Classe I IP20

Unit: cm

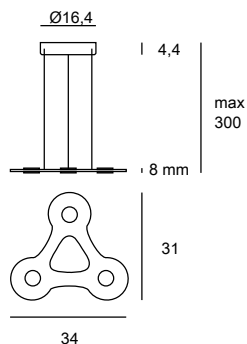
FLAT RING 3**Suspension lamp**

172 Natural Anodized aluminium
174 Black Anodized aluminium
177 Champagne Gold

LED 18,9W 1700lm 2700K CRI>90
LED 18,9W 1890lm 3000K CRI>90
Dimmable TRIAC

CE  Classe I IP20

Unit: cm

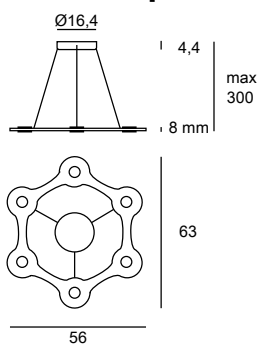
FLAT RING 6**Suspension lamp**

172 Natural Anodized aluminium
174 Black Anodized aluminium
177 Champagne Gold

LED 37,8W 3420lm 2700K CRI>90
LED 37,8W 3800lm 3000K CRI>90
Dimmable TRIAC

CE  Classe I IP20

Unit: cm

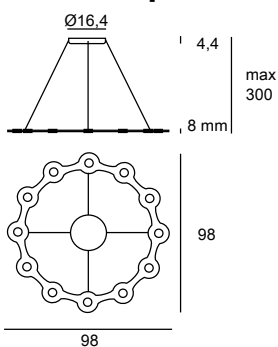
FLAT RING 12**Suspension lamp**

172 Natural Anodized aluminium
174 Black Anodized aluminium
177 Champagne Gold

LED 75,6W 6800lm 2700K CRI>90
LED 75,6W 7560lm 3000K CRI>90
Dimmable TRIAC

CE  Classe I IP20

Unit: cm

FLAT SATURN 1 Suspension lamp

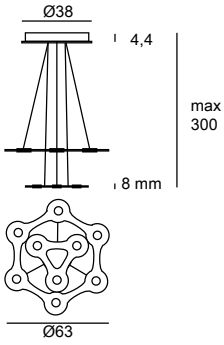

- 172 Natural Anodized aluminium
- 174 Black Anodized aluminium
- 177 Champagne Gold

LED 56,7W 5100lm 2700K CRI>90
LED 56,7W 5670lm 3000K CRI>90
Dimmable TRIAC

Classe I IP20

Unit: cm

FLAT SATURN 2 Suspension lamp

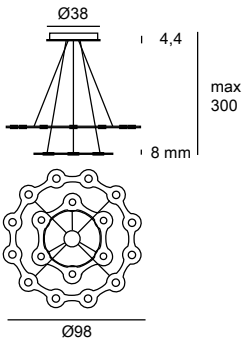

- 172 Natural Anodized aluminium
- 174 Black Anodized aluminium
- 177 Champagne Gold

LED 113,4W 10170lm 2700K CRI>90
LED 113,4W 11300lm 3000K CRI>90
Dimmable TRIAC

Classe I IP20

Unit: cm

FLAT SATURN 3 Suspension lamp

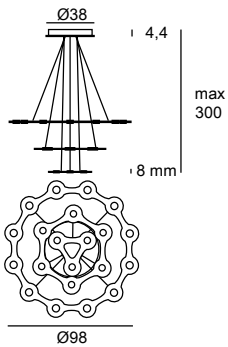

- 172 Natural Anodized aluminium
- 174 Black Anodized aluminium
- 177 Champagne Gold

LED 132,3W 11900lm 2700K CRI>90
LED 132,3W 13323lm 3000K CRI>90
Dimmable TRIAC

Classe I IP20

Unit: cm



_ Planets Collection







_ Planets Collection

Design Jamo Associates

IL MAGNETISMO DELLA SFERA

Disegnata da Jamo Associates, Planets come un luminoso sistema di corpi celesti prende ispirazione dal fascino senza tempo e dal magnetismo dei pianeti.

THE MAGNETISM OF THE SPHERE

Designed by Jamo Associates, as a shining system of celestial bodies, Planets draws inspiration from the timeless fascination and from the magnetism of the planets.

LE MAGNÉTISME DE LA SPHÈRE

Dessinée par Jamo Associates, Planets se présente comme un système lumineux de corps célestes et s'inspire du charme et du magnétisme intemporel des planètes.

DER MAGNETISMUS DER KUGELFORM

Entworfen von Jamo Associates, wurde Planets vom zeitlosen Reiz und vom Magnetismus der Planeten inspiriert, wie ein scheinendes System aus Himmelskörpern.

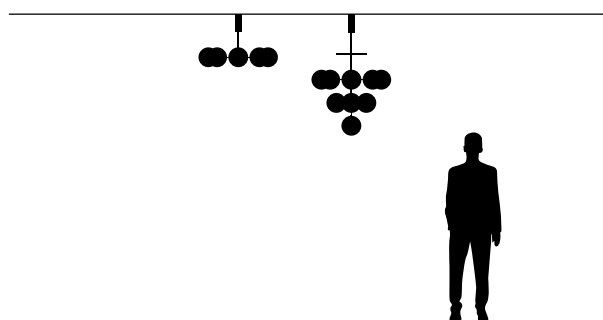

PLANETS 08-13**Suspension lamp**

—
Lampada a sospensione realizzata in ottone e sfere in vetro bianco opale lucido. Disponibile in 2 differenti versioni a 8 e 13 sfere.
Finitura in nero ft.

—
Suspension lamp made of brass and spheres in glossy opal white glass. Available in 2 different versions, with 8 or 13 spheres. Finish in black ft .

—
Suspension en laiton avec sphères en verre blanc opale poli.
Disponible en 2 versions différentes avec 8 et 13 sphères.
Finition en noir ft.

—
Entworfen von Jamo Associates, wurde Planets vom zeitlosen Reiz und vom Magnetismus der Planeten inspiriert, wie ein scheinendes System aus Himmelskörpern.



PLANETS 08

Suspension lamp

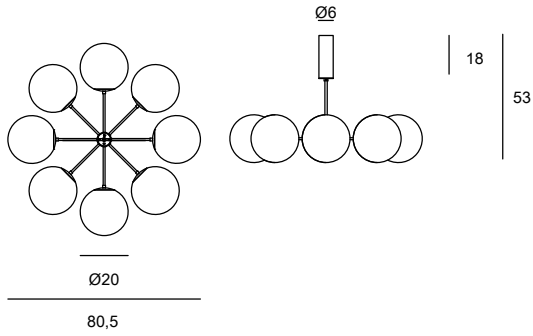

103 Black FT

8xE14

Dimmable according to bulb

CE  Classe I IP20

Unit: cm

PLANETS 13

Suspension lamp

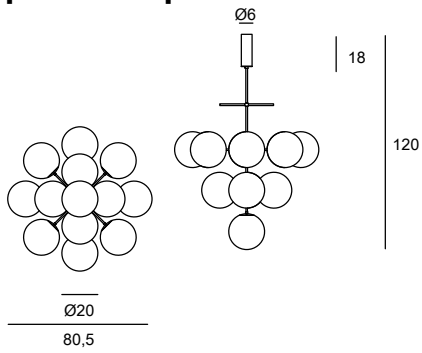

103 Black FT

13xE14

Dimmable according to bulb

CE  Classe I IP20

Unit: cm



Photo By Emma Onesti @ SAG 80 Milano

_ Odile Family







— Odile Family

Design P. Cappello

L'EQUILIBRIO DELLA SEMPLICITÀ

Disegnata da Paolo Cappello, Odile equilibra l'eleganza delle forme alla semplicità delle linee. La sua struttura avvolgente e dolce insieme all'utilizzo sapiente del colore rendono l'effetto d'insieme armonioso e delicato.

THE BALANCE OF SIMPLICITY

Designed by Paolo Cappello, Odile balances the elegance of their profiles with linear simplicity. Its enveloping, wispy structure and the refined use of pastel tones makes the overall effect delicate and harmonious.

L'ÉQUILIBRE DE LA SIMPLICITÉ

Dessinée par Paolo Cappello, Odile allie harmonieusement l'élégance des formes et la simplicité des lignes. Ses formes douces et enveloppantes ainsi que l'utilisation habile de la couleur confèrent à l'ensemble un charme harmonieux et délicat.

DIE BALANCE DER EINFACHHEIT

Entworfen von Paolo Cappello, balanciert Odile die Eleganz ihres Profils mit linearer Einfachheit aus. Seine umhüllende, hauchzarte Struktur und die raffinierte Verwendung von Pastelltönen sorgen für eine zarte und harmonische Gesamtwirkung.

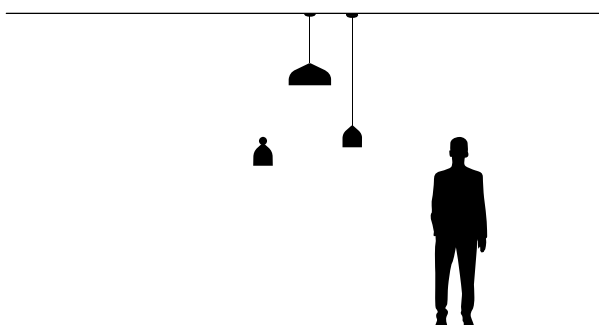

ODILE 21**Wall lamp**

—
Lampada da parete con calotta realizzata in alluminio tornito e struttura portante in metallo. Disponibile in bianco ft, nero ft, verde salvia ft, senape ft e bronzo verniciato.

—
Wall lamp with shade in turned aluminum and body in metal. Available in white ft, black ft, sage green ft, mustard ft and painted bronze.

—
Applique murale avec coque en aluminium et structure en métal. Disponible en blanc ft, noir ft, vert sauge ft, moutarde ft et bronze peint.

—
Wandlampe mit Lampenschirm aus gedrehtem Aluminium und Körper aus Metall. Verfügbar in weiß ft, schwarz ft, salbeigrün ft, senf ft und lackierter Bronze.



ODILE S - M**Suspension lamp**

—
Lampada a sospensione con calotta realizzata in alluminio tornito e disponibile in 2 diversi diametri. Grazie ai molteplici rosoni ed ai suoi colori distintivi è possibile creare composizioni uniche e personalizzate. Disponibile in bianco ft, nero ft, verde salvia ft, senape ft e bronzo verniciato.

—
Suspension lamp with shade in turned aluminum and available in 2 different diameters. Thanks to its multitude of ceiling roses and its distinctive colors it is possible to create unique, personalized compositions. Available in white ft, black ft, sage green ft, mustard ft and painted bronze.

—
Suspension avec coque en aluminium, disponible en deux diamètres différents. Grâce à ses multiples rosaces et ses différentes couleurs, il est possible de créer des compositions uniques et personnalisées. Disponible en blanc ft, noir ft, vert sauge ft, moutarde ft et bronze peint.

—
Hängelampe mit Lampenschirm aus gedrehtem Aluminium und verfügbar in 2 verschiedenen Durchmesser. Dank der zahlreichen Rosetten und ihrer unverwechselbaren Farben können einzigartige und individuelle Kompositionen geschaffen werden. Verfügbar in weiß ft, schwarz ft, salbeigrün ft, senf ft und lackierter Bronze.



ODILE 21
Wall lamp

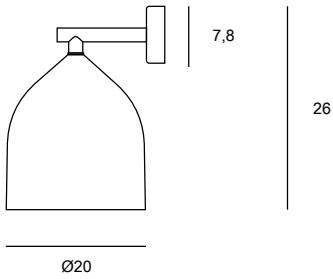

- 103 Black FT
- 105 White FT
- 126 Sage Green FT
- 127 Senape FT
- 175 Painted Bronze

1xE27
Dimmable according to bulb

CE  Classe I IP20

Unit: cm

ODILE S
Suspension lamp

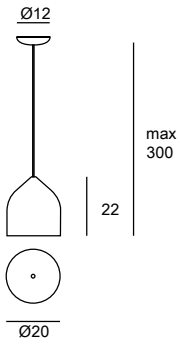

- 103 Black FT
- 105 White FT
- 126 Sage Green FT
- 127 Senape FT
- 175 Painted Bronze

1xE27
Dimmable according to bulb

CE   IP20

Unit: cm

ODILE M
Suspension lamp

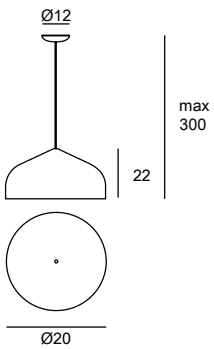

- 103 Black FT
- 105 White FT
- 126 Sage Green FT
- 127 Senape FT
- 175 Painted Bronze

1xE27
Dimmable according to bulb

CE   IP20

Unit: cm

_ ADDITIONAL CEILING ROSES

**MULTI 3
Ceiling Rose**

105 White FT

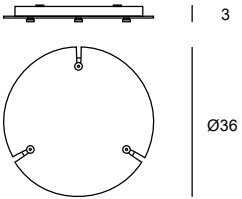

Unit: cm

**MULTI 5
Ceiling Rose**

105 White FT

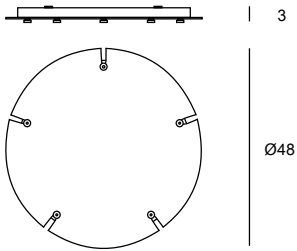

Unit: cm

**PENDANT 3
Ceiling Rose**

105 White FT

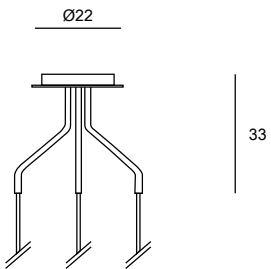

Unit: cm

**PENDANT 5
Ceiling Rose**

105 White FT

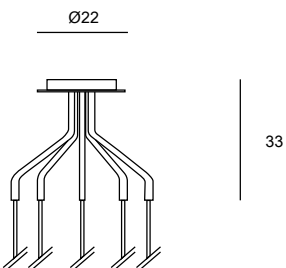

Unit: cm

_ Zero Family







_ Zero Family

Design P. Cappello

L'ESSENZIALITÀ DEL CERCHIO

Disegnata da Paolo Cappello, la famiglia Zero si ispira al simbolo matematico per eccellenza per creare un effetto essenziale, elegante e rifinito in ogni suo dettaglio.

THE ESSENTIAL NATURE OF THE CIRCLE

Designed by Paolo Cappello, the Zero family draws inspiration from the perfect mathematical symbol to create an essential effect that is both elegant and perfectly refined in every detail.

L'ESSENTIALITÉ DU CERCLE

Dessinée par Paolo Cappello, la famille Zero s'inspire du symbole mathématique par excellence pour obtenir un effet qui se veut essentiel, élégant et raffiné dans les moindres détails.

DIE ESSENZIELLE NATUR DES KREISES

Entwickelt von Paolo Cappello, lässt sich die Zero Family vom perfekten mathematischen Symbol inspirieren, um eine essenzielle Wirkung zu erzielen, die sowohl elegant als auch bis ins kleinste Detail perfekt ausgearbeitet ist.

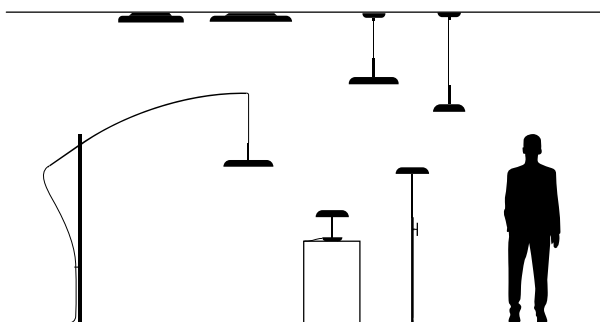









ZERO S - M - L**Suspension lamp**

—
Lampada a sospensione realizzata in alluminio tornito e disponibile in 3 diametri. Sorgente LED integrata ed alimentatore elettronico dimmerabile TRIAC, versione Dali su richiesta. Disponibile in bianco ft, nero ft, red brown ft e gres dove-grey ft con dettagli in oro anodizzato.

—
Suspension lamp made of turned aluminum and available in 3 diameters. Embedded LED light sources and TRIAC dimmable power supply included. Dali version on request. Finishes in white ft, black ft, red brown ft and gres dove-grey ft with details in anodized gold.

—
Suspension en aluminium tourné, disponible en 3 diamètres. Source LED intégrée et driver dimmable TRIAC, version Dali sur demande. Disponible en blanc ft, noir ft, red brown ft et gres dove-grey ft avec détails en or anodisé.

—
Hängelampe aus gedrehtem Aluminium und verfügbar in 3 Durchmesser. Integrierte LED-Lichtquelle und TRIAC dimmbare Stromversorgung. Dali Version auf Anfrage. Verfügbar in weiß ft, schwarz ft, rotbraun ft und gres dove-grau ft mit Verzierungen in eloxiertem Gold.



ZERO 40 - 50 - 60 - 80**Ceiling lamp**

—
Lampada da soffitto realizzata in alluminio tornito e disponibile in 4 diametri. Sorgente LED integrata ed alimentatore elettronico dimmerabile TRIAC, versione Dali su richiesta. Disponibile in bianco ft, nero ft, red brown ft e gres dove-grey ft.

—
Ceiling lamp made of turned aluminum and available in 4 diameters. Embedded LED light sources and TRIAC dimmable power supply included. Dali version on request. Available in white ft, black ft, red brown ft and gres dove-grey ft.

—
Plafonnier en aluminium tourné, disponible en 4 diamètres. Source LED intégrée et driver dimmable TRIAC, version Dali sur demande. Disponible en blanc ft, noir ft, red brown ft et gres dove-grey ft.

—
Deckenlampe aus gedrehtem Aluminium und verfügbar in 4 Durchmesser. Integrierte LED-Lichtquelle und TRIAC dimmbare Stromversorgung. Dali Version auf Anfrage. Verfügbar in weiß ft, schwarz ft, rotbraun ft und gres dove-grau ft.



ZERO 02**Table lamp**

—
Lampada da tavolo della famiglia Zero con sorgente LED integrata e push dimmer con driver integrato nella base. Disponibile in bianco ft, nero ft, red brown ft e gres dove-grey ft con dettagli in oro anodizzato.

—
Table lamp of Zero family with embedded LED light sources and push dimmable power supply with integrated driver on the base. Finishes in white ft, black ft, red brown ft and gres dove-grey ft with details in anodized gold.

—
Lampe à poser de la famille Zero avec source LED intégrée et variateur d'intensité avec bouton poussoir et driver intégré dans la base. Disponible en blanc ft, noir ft, red brown ft et gres dove-grey ft avec détails en or anodisé.

—
Tischlampe der Zero Familie mit integrierter LED-Lichtquelle und push dimmbare Stromversorgung mit integriertem Treiber auf dem Sockel. Verfügbar in weiß ft, schwarz ft, rotbraun ft und gres dove-grau ft mit Verzierungen in eloxiertem Gold.



ZERO 09
Floor lamp

—
Lampada da lettura della famiglia Zero, è regolabile in altezza grazie ad una chiave posta sullo stelo della lampada. Sorgente LED integrata e dimmer a pedale con driver incluso. Disponibile in bianco ft e nero ft con dettagli in oro anodizzato.

—
Reading lamp of Zero family. Its height is adjustable by means of a key on the lamp stem. Embedded LED light sources and pedal dimmable power supply with integrated driver. Finishes in white ft and black ft with details in anodized gold.

—
Lampe de lecture de la famille Zero, réglable en hauteur grâce à une clé située sur la tige de la lampe. Source LED intégrée et variateur d'intensité à pédale avec driver inclus. Disponible en blanc ft, noir ft avec détails en or anodisé.

—
Leselampe der Zero Familie. Ihre Höhe ist mit Hilfe eines Schlüssels auf dem Lampenstiel einstellbar. Integrierte LED-Lichtquellen und dimmbare Pedal-Stromversorgung mit integriertem Treiber. Verfügbar in weiß ft und schwarz ft mit Verzierungen in eloxiertem Gold.



ZERO 11
Floor lamp

—
Lampada da terra della famiglia Zero, il suo punto luce è regolabile sia in altezza che in estensione tramite il riposizionamento dell'asta ricurva. Sorgente LED integrata e dimmer a pedale con driver incluso. Disponibile in bianco ft e nero ft con dettagli in oro anodizzato.

—
Floor lamp of Zero family. Its light point is adjustable in both height and extension by repositioning the curved rod. Embedded LED light sources and pedal dimmable power supply with integrated driver. Finishes in white ft and black ft with details in anodized gold.

—
Lampadaire de la famille Zero, son point lumineux se règle en hauteur et en longueur en repositionnant la tige courbée. Source LED intégrée et variateur d'intensité à pédale avec driver inclus. Disponible en blanc ft, noir ft avec détails en or anodisé.

—
Stehlampe der Zero Familie. Der Lichtpunkt ist sowohl in der Höhe als auch in der Ausdehnung verstellbar, indem der gebogene Stab neu positioniert wird. Integrierte LED-Lichtquellen und dimmbare Pedal-Stromversorgung mit integriertem Treiber. Verfügbar in weiß ft und schwarz ft mit Verzierungen in eloxiertem Gold.



ZERO S

Suspension lamp

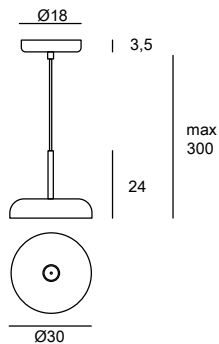

- 103 Black FT
- 105 White FT
- 138 Red-Brown FT
- 140 Gres Dove-grey FT

LED SMD 15W 1150lm 2700K CRI>90
 LED SMD 15W 1200lm 3000K CRI>90
 Dimmable TRIAC (DALI on request)

CE  Classe I IP20

Unit: cm

ZERO M

Suspension lamp

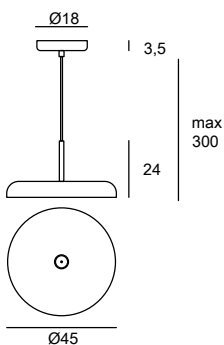

- 103 Black FT
- 105 White FT
- 138 Red-Brown FT
- 140 Gres Dove-grey FT

LED SMD 28W 2020lm 2700K CRI>90
 LED SMD 28W 2100lm 3000K CRI>90
 Dimmable TRIAC (DALI on request)

CE  Classe I IP20

Unit: cm

ZERO L

Suspension lamp

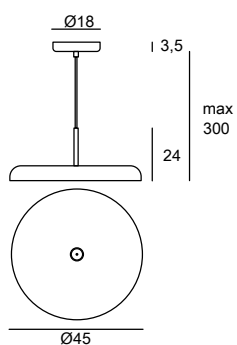

- 103 Black FT
- 105 White FT
- 138 Red-Brown FT
- 140 Gres Dove-grey FT

LED SMD 48W 3456lm 2700K CRI>90
 LED SMD 48W 3600lm 3000K CRI>90
 Dimmable TRIAC (DALI on request)

CE  Classe I IP20

Unit: cm

ZERO 40

Ceiling lamp

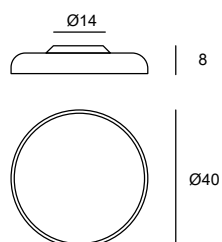

- 103 Black FT
- 105 White FT
- 138 Red-Brown FT
- 140 Gres Dove-grey FT

LED SMD 28W 2100lm 2700K CRI>90
LED SMD 28W 2200lm 3000K CRI>90
Dimmable TRIAC (DALI on request)

CE  Classe I IP20

Unit: cm

ZERO 50

Ceiling lamp

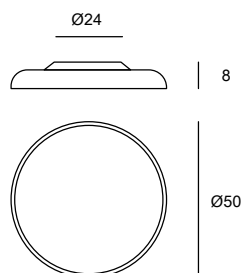

- 103 Black FT
- 105 White FT
- 138 Red-Brown FT
- 140 Gres Dove-grey FT

LED SMD 44W 3260lm 2700K CRI>90
LED SMD 44W 3400lm 3000K CRI>90
Dimmable TRIAC (DALI on request)

CE  Classe I IP20

ZERO 60

Ceiling lamp

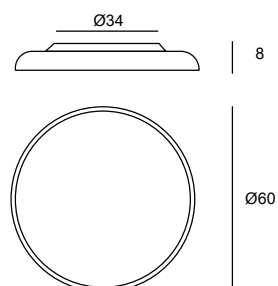

- 103 Black FT
- 105 White FT
- 138 Red-Brown FT
- 140 Gres Dove-grey FT

LED SMD 56W 4300lm 2700K CRI>90
LED SMD 56W 4480lm 3000K CRI>90
Dimmable TRIAC (DALI on request)

CE  Classe I IP20

Unit: cm

ZERO 80

Ceiling lamp

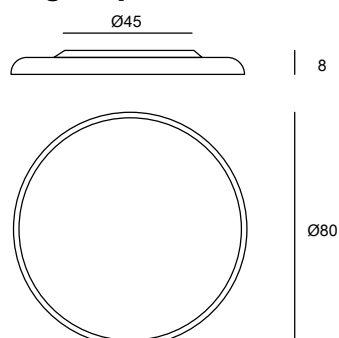

- 103 Black FT
- 105 White FT
- 138 Red-Brown FT
- 140 Gres Dove-grey FT

LED SMD 90W 6750lm 2700K CRI>90
LED SMD 90W 7200lm 3000K CRI>90
Dimmable TRIAC (DALI on request)

CE  Classe I IP20

Unit: cm

ZERO 02

Table lamp

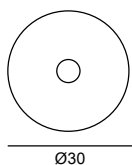
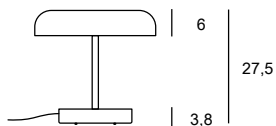

- 103 Black FT
- 105 White FT
- 138 Red-Brown FT
- 140 Gres Dove-grey FT

LED SMD 15W 1150lm 2700K CRI>90
 LED SMD 15W 1200lm 3000K CRI>90
 Push dimmer on the base

CE Classe I IP20

Unit: cm

ZERO 09

Floor lamp

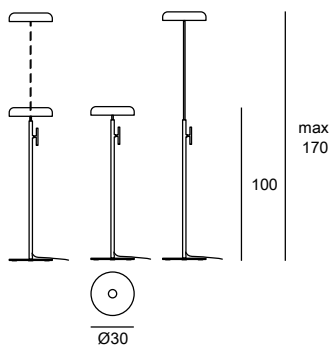

- 103 Black FT
- 105 White FT

LED SMD 15W 1150lm 2700K CRI>90
 LED SMD 15W 1200lm 3000K CRI>90
 Foot dimmer

CE Classe I IP20

Unit: cm

ZERO 11

Floor lamp

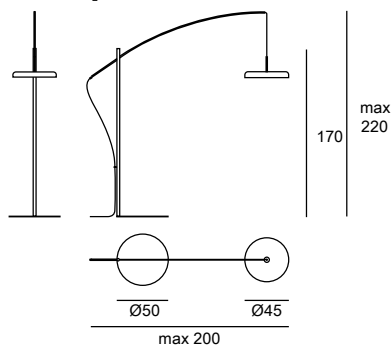

- 103 Black FT
- 105 White FT

LED SMD 28W 2020lm 2700K CRI>90
 LED SMD 28W 2100lm 3000K CRI>90
 Foot dimmer

CE Classe I IP20

Unit: cm



_ Ice Family







_ Ice Family

Design VillaTosca, LCI.LAB

SFERE DI LUCE

Disegnata da VillaTosca, Ice è una famiglia di lampade a sospensione che con le sue caratteristiche linee morbide e minimali crea suggestivi giochi di luce che si adattano a svariati ambienti.

SPHERES OF LIGHT

Designed by VillaTosca, Ice is a family of suspension lamps that, with its characteristic soft, minimalist lines, create striking plays of light that suit a variety of environments.

SPHÈRES DE LUMIÈRE

Dessinée par VillaTosca, Ice est une famille de suspensions capable, avec ses lignes douces et minimalistes qui la caractérisent, de créer des jeux de lumière suggestifs adaptés à une multitude d'environnements.

KUGELN AUS LICHT

Entworfen von VillaTosca, ist Ice eine Familie von Hängelampen, die, mit ihren weichen, minimalen Linien, eindrucksvolle Lichtspiele erzeugen, die zu einer Vielzahl von Umgebungen passen.

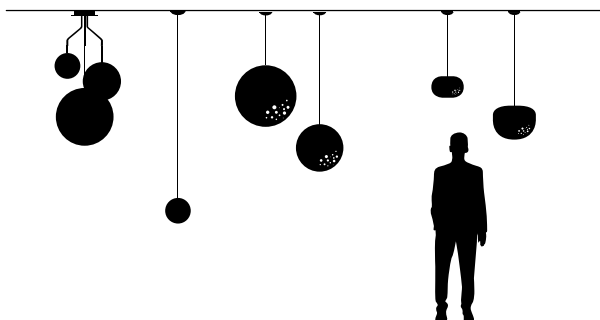





SUMO S - M - L**Suspension lamp**

—
Lampada a sospensione realizzata in polycarbonato PC microforato disponibile in 3 forme e misure. La sua unica texture simula una superficie ghiacciata che grazie ai suoi molteplici rosoni consente di creare composizioni uniche.

—
Suspension lamp made of PC micro perforated polycarbonate and available in 3 forms and measures. Its unique texture recalls an icy surface that allows unique compositions to be created thanks to its multiple ceiling roses.

—
Suspension en polycarbonate PC microperforé disponible en 3 formes et dimensions. Sa texture unique simule une surface givrée et ses multiples rosaces permettent de créer des compositions uniques.

—
Hängelampe aus mikroperforiertem PC-Polycarbonat, erhältlich in 4 Formen und Durchmessern. Ihre einzigartige Textur erinnert an eine eisige Oberfläche, die dank der zahlreichen Deckenrosetten einzigartige Kompositionen ermöglicht.





ICELIGHT 20 - 30 - 45 - 60**Suspension lamp**

—
Lampada a sospensione realizzata in policarbonato PC microforato e disponibile in 4 diametri. La sua unica texture simula una superficie ghiacciata che grazie ai suoi molteplici rosoni consente di creare composizioni uniche.

—
Suspension lamp made of PC micro perforated polycarbonate and available in 4 diameters. Its unique texture recalls an icy surface that allows unique compositions to be created thanks to its multiple ceiling roses.

—
Suspension en polycarbonate PC microperforé, disponible en 4 diamètres. Sa texture unique simule une surface givrée et ses multiples rosaces permettent de créer des compositions uniques.

—
Hängelampe aus mikroperforiertem PC-Polycarbonat, erhältlich in 4 Durchmessern. Ihre einzigartige Textur erinnert an eine eisige Oberfläche, die dank der zahlreichen Deckenrosetten einzigartige Kompositionen ermöglicht.





FULLMOON 20 - 30 - 45 - 60**Suspension lamp**

—
Lampada a sospensione realizzata in PE bianco opaco e disponibile in 4 diametri. I suoi molteplici rosoni consentono di creare composizioni uniche e personalizzate.

—
Suspension lamp made of opal white PE and available in 4 diameters. With its multitude of ceiling roses and its distinctive colors it is possible to create unique, personalized combinations.

—
Suspension fabriquée en PE blanc mat et disponible en 4 diamètres. Ses multiples rosaces permettent de créer des compositions uniques et personnalisées.

—
Hängelampe aus opalweißem PE und in 4 Durchmessern erhältlich. Mit seiner Vielzahl an Deckenrosetten und seinen unterschiedlichen Farben ist es möglich, einzigartige, persönliche Kombinationen zu schaffen.



SUMO S

Suspension lamp

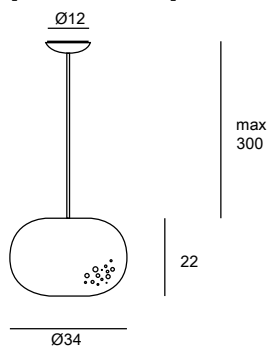

□ ABS White

Diffuser: PC Polycarbonate

1xE27

Dimmable according to bulb

CE IP20

Unit: cm

SUMO M

Suspension lamp

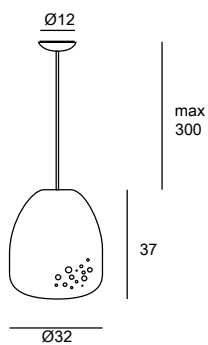

□ ABS White

Diffuser: PC Polycarbonate

1xE27

Dimmable according to bulb

CE IP20

Unit: cm

SUMO L

Suspension lamp

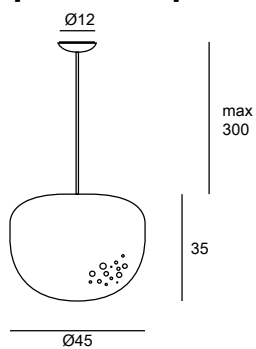

□ ABS White

Diffuser: PC Polycarbonate

1xE27

Dimmable according to bulb

CE IP20

Unit: cm

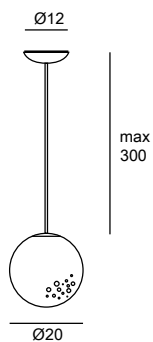
ICELIGHT 20**Suspension lamp**

□ ABS White

Diffuser: PC Polycarbonate

1xE27

Dimmable according to bulb

CE IP20

Unit: cm

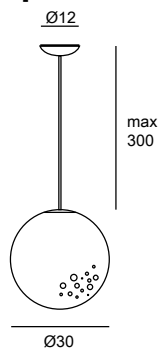
ICELIGHT 30**Suspension lamp**

□ ABS White

Diffuser: PC Polycarbonate

1xE27

Dimmable according to bulb

CE IP20

Unit: cm

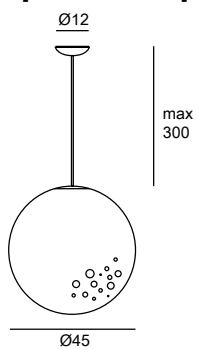
ICELIGHT 45**Suspension lamp**

□ ABS White

Diffuser: PC Polycarbonate

1xE27

Dimmable according to bulb

CE IP20

Unit: cm

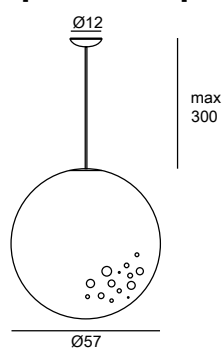
ICELIGHT 60**Suspension lamp**

□ ABS White

Diffuser: PC Polycarbonate

1xE27

Dimmable according to bulb

CE IP20

Unit: cm

FULLMOON 20 Suspension lamp

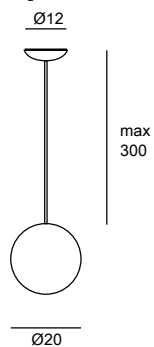

□ ABS White

Diffuser: PE Polyethylene Opal White

1xE27

Dimmable according to bulb

CE IP20

Unit: cm

FULLMOON 30 Suspension lamp

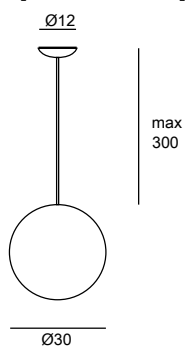

□ ABS White

Diffuser: PE Polyethylene Opal White

1xE27

Dimmable according to bulb

CE IP20

Unit: cm

FULLMOON 45 Suspension lamp

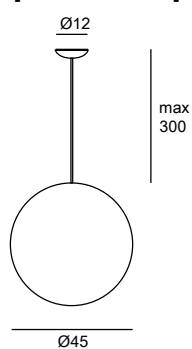

□ ABS White

Diffuser: PE Polyethylene Opal White

1xE27

Dimmable according to bulb

CE IP20

Unit: cm

FULLMOON 60 Suspension lamp

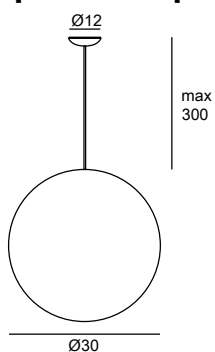

□ ABS White

Diffuser: PE Polyethylene Opal White

1xE27

Dimmable according to bulb

CE IP20

Unit: cm

_ ADDITIONAL CEILING ROSES

**MULTI 3 - 5
Ceiling Rose**

105 White FT

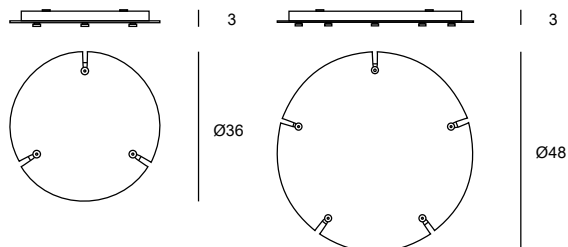

Unit: cm

**PENDANT 3 - 5
Ceiling Rose**

105 White FT

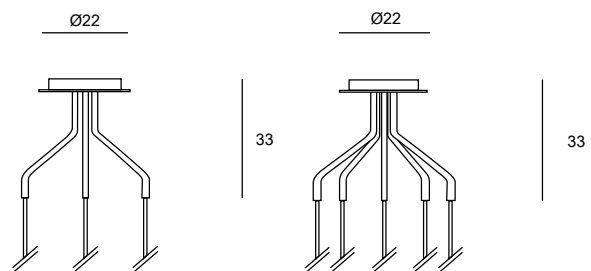

Unit: cm

**CLUSTER (Max 9)
Ceiling Rose**

105 White FT

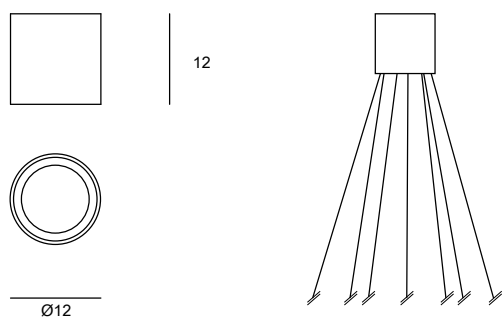

Unit: cm

_ Také Family







_ Také Family

Design VillaTosca

ECOSISTEMI DI LUCE

Disegnata da VillaTosca, Také ha linee flessuose, essenziali e armoniose, che ricordano la forma del bambù, caratterizzate dal perfetto equilibrio tra flessibilità d'utilizzo e personalità estetica.

ECOSYSTEMS OF LIGHT

Designed by VillaTosca, Také has graceful, essential, and harmonious lines that recall the shape of bamboo featuring the perfect balance between flexibility of use and aesthetic personality.

ÉCOSYSTÈMES DE LUMIÈRE

Dessinée par VillaTosca, Také présente des lignes souples, essentielles et harmonieuses, rappelant la forme du bambou, caractérisées par l'équilibre parfait entre la souplesse d'utilisation et la personnalité esthétique.

ÖKOSYSTEM DES LICHTS

Entworfen von VillaTosca, hat Také anmutige, essenzielle und harmonische Linien, die an die Form des Bamboos erinnern und ein perfektes Gleichgewicht zwischen Nutzungsflexibilität und ästhetischer Persönlichkeit bieten.

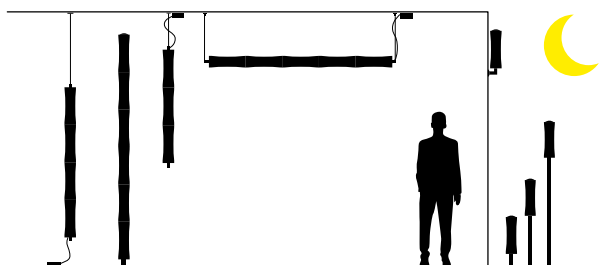

TAKÉ PLUS BT 04 - 05 - 06**Floor lamp**

—
Lampada da terra realizzata in PE bianco opale a 4, 5 e 6 moduli. Sorgente LED integrata e dimmer a pedale o a controllo Bluetooth incluso. La base e il dimmer sono disponibili in bianco opaco o cromo.

—
Floor lamp made of PE opal white with 4, 5 and 6 modules. Embedded LED light sources and pedal dimmable power supply Bluetooth control. Base and dimmer are available with finishes in matte white or chrome.

—
Lampadaire en PE blanc opale à 4, 5 et 6 éléments. Source LED intégrée et variateur à pédale ou piloté par Bluetooth inclus. La base et le variateur sont disponibles en blanc mat ou chromés.

—
Stehlampe aus mattweißem PE und mit 3,4,5 und 6 Modulen erhältlich. Integrierte LED-Lichtquellen und dimmbare Pedal-Stromversorgung durch Bluetooth-Steuerung. Grund und Dimmer verfügbar mit Verzierungen in mattweiß oder Chrom.



TAKÉ PLUS S3 - S4 - S5 - S6**Suspension lamp**

—
Lampada a sospensione realizzata in PE bianco opale a 3, 4 ,5 e 6 moduli. Gli attacchi consentono di personalizzare l'inclinazione della lampada. Sorgente LED integrata e alimentatore ON-OFF o dimmerabile tramite controllo Bluetooth. I dettagli sono disponibili in bianco opaco o cromo.

—
Suspension lamp made of PE white opal with 3, 4 ,5 and 6 modules. The mounts allow the user to adjust the lamp's inclination . Embedded LED light sources and ON-OFF dimmable power supply through Bluetooth control. Available with finishes in matte white or chrome.

—
Suspension en PE blanc opale à 3, 4 ,5 et 6 éléments. Les attaches fournies permettent de personnaliser l'inclinaison de la lampe. Source LED intégrée et alimentation ON-OFF ou dimmable via Bluetooth. Les détails sont disponibles en blanc mat ou chromés.

—
Hängelampe aus opalweißem PE und mit 3,4,5 und 6 Modulen erhältlich. Die Halterungen ermöglichen es dem Benutzer, die Neigung der Lampe einzustellen. Integrierte LED-Lichtquellen und dimmbare ON-OFF-Stromversorgung durch Bluetooth-Steuerung. Verfügbar mit den Verzierungen in mattweiß oder Chrom.



TAKÉ PLUS BT S&P 04 - 05 - 06**Ceiling lamp**

—
Lampada a soffitto-pavimento della famiglia Také a 4, 5 e 6 moduli. Sorgente LED integrata e dimmer a pedale o a controllo Bluetooth incluso. I dettagli sono disponibili in bianco opaco o cromo.

—
Ceiling-floor lamp from Také family with 4, 5 or 6 moduls. Embedded LED light sources and pedal dimmable power supply Bluetooth control. Available with finishes in matte white or chrome.

—
Lampe plafond-sol de la famille Také à 4, 5 et 6 éléments. Source LED intégrée et variateur à pédale ou piloté par Bluetooth inclus. Les détails sont disponibles en blanc mat ou chromés.

—
Deckenlampe von der Také Familie mit 4,5 und 6 Modulen erhältlich. Integrierte LED-Lichtquellen und dimmbare Pedal-Stromversorgung durch Bluetooth-Steuerung. Verfügbar mit Verzierungen in mattweiß oder Chrom.







TAKÉ OPEN AIR 03- 10 - 11 - 21**Outdoor lamp**

—
Lampade da esterno della famiglia Také con ancoraggio al terreno personalizzato, sono disponibili sia in versione da parete che da terra in tre differenti altezze. Finitura in nero ft.

—
Outdoor lamps of Také family with customizable ground mounting. Available both as wall lamp and floor lamp in three different heights. Finishes in black ft.

—
Système d'éclairage extérieur de la famille Také avec fixation personnalisable au sol, disponibles à la fois en version murale et posée au sol, avec trois hauteurs différentes. Finition en noir ft.

—
Außenlampen aus der Také Familie mit anpassbarer Bodenbefestigung. Erhältlich sowohl als Wandlampe als auch als Stehlampe in drei verschiedenen Höhen. Verzierungen in schwarz ft.



TAKÉ PLUS BT 04

Floor lamp

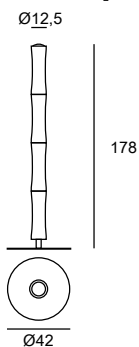

106 Matte White
150 Chrome

Diffuser: PE Polyethylene Opal White

LED 64W 4400lm 3000K CRI>90
ON-OFF foot dimmer with Bluetooth Control through application for Android and iOS systems

CE Classe I IP20

Unit: cm

TAKÉ PLUS BT 05

Floor lamp

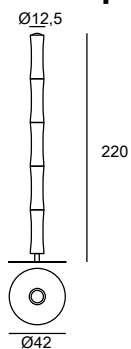

106 Matte White
150 Chrome

Diffuser: PE Polyethylene Opal White

LED 80W 5500lm 3000K CRI>90
ON-OFF foot dimmer with Bluetooth Control through application for Android and iOS systems

CE Classe I IP20

Unit: cm

TAKÉ PLUS BT 06

Floor lamp

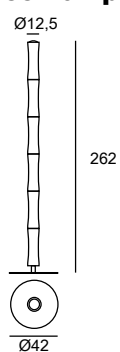

106 Matte White
150 Chrome

Diffuser: PE Polyethylene Opal White

LED 96W 6600lm 3000K CRI>90
ON-OFF foot dimmer with Bluetooth Control through application for Android and iOS systems

CE Classe I IP20

Unit: cm

TAKÉ PLUS S3 (BT or ON-OFF)

Suspension lamp

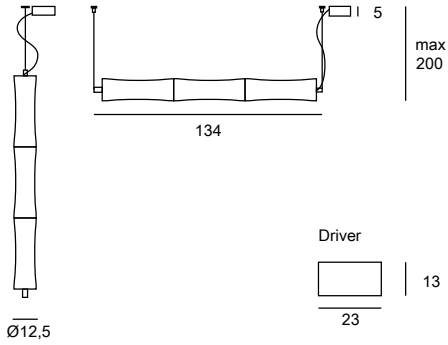

106 Matte White
150 Chrome

Diffuser: PE Polyethylene Opal White

LED 48W 3300lm 3000K CRI>90
ON-OFF or Bluetooth Control with application for Android and iOS systems

CE Classe I IP20

Unit: cm

TAKÉ PLUS S4 (BT or ON-OFF)

Suspension lamp

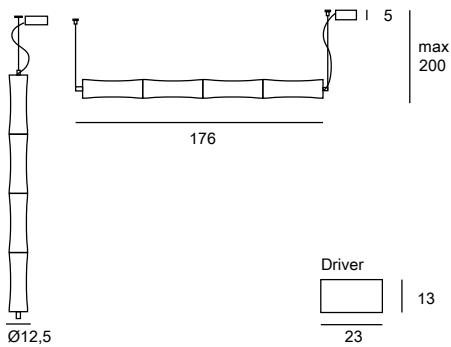

106 Matte White
150 Chrome

Diffuser: PE Polyethylene Opal White

LED 64W 4400lm 3000K CRI>90
ON-OFF or Bluetooth Control with application for Android and iOS systems

CE Classe I IP20

Unit: cm

TAKÉ PLUS S5 (BT or ON-OFF)

Suspension lamp

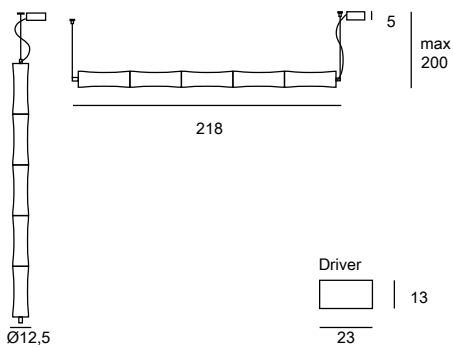

106 Matte White
150 Chrome

Diffuser: PE Polyethylene Opal White

LED 80W 5500lm 3000K CRI>90
ON-OFF or Bluetooth Control with application for Android and iOS systems

CE Classe I IP20

Unit: cm

TAKÉ PLUS S6 (BT or ON-OFF)

Suspension lamp

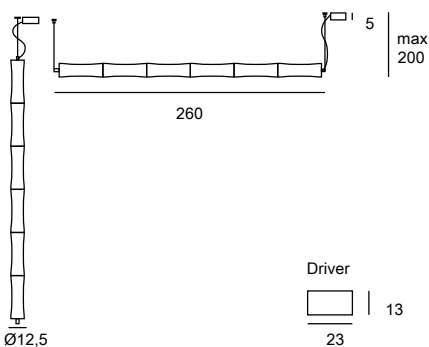

106 Matte White
150 Chrome

Diffuser: PE Polyethylene Opal White

LED 96W 6600lm 3000K CRI>90
ON-OFF or Bluetooth Control with application for Android and iOS systems

CE Classe I IP20

Unit: cm

TAKÉ PLUS BT S&P 04

Ceiling lamp

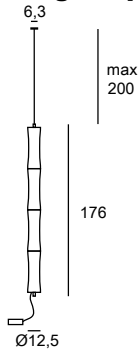

106 Matte White
150 Chrome

Diffuser: PE Polyethylene Opal White

LED 64W 4400lm 3000K CRI>90
ON-OFF foot dimmer with Bluetooth Control through application for Android and iOS systems

CE  Classe I IP20

Unit: cm

TAKÉ PLUS BT S&P 05

Ceiling lamp

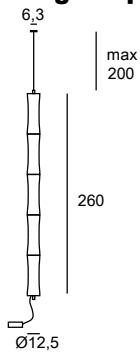

106 Matte White
150 Chrome

Diffuser: PE Polyethylene Opal White

LED 80W 5500lm 3000K CRI>90
ON-OFF foot dimmer with Bluetooth Control through application for Android and iOS systems

CE  Classe I IP20

Unit: cm

TAKÉ PLUS BT S&P 06

Ceiling lamp

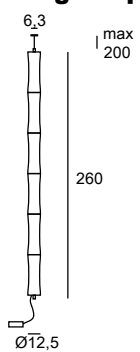

106 Matte White
150 Chrome

Diffuser: PE Polyethylene Opal White

LED 96W 6600lm 3000K CRI>90
ON-OFF foot dimmer with Bluetooth Control through application for Android and iOS systems

CE  Classe I IP20

Unit: cm

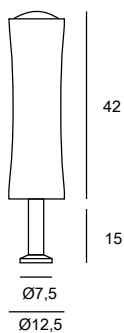
TAKÉ OPEN AIR 03**Outdoor lamp**

■ 103 Black FT

Diffuser: PE Polyethylene Opal White

1xE27
ON-OFF

Classe I IP54

Unit: cm

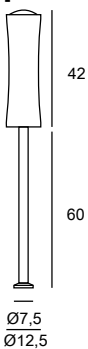
TAKÉ OPEN AIR 10**Suspension lamp**

■ 103 Black FT

Diffuser: PE Polyethylene Opal White

1xE27
ON-OFF

Classe I IP54

Unit: cm

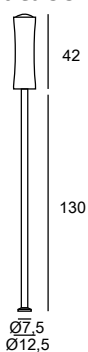
TAKÉ OPEN AIR 11**Outdoor lamp**

■ 103 Black FT

Diffuser: PE Polyethylene Opal White

1xE27
ON-OFF

Classe I IP54

Unit: cm

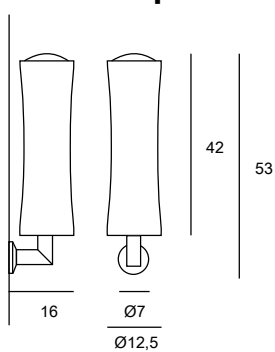
TAKÉ OPEN AIR 21**Outdoor lamp**

■ 103 Black FT

Diffuser: PE Polyethylene Opal White

1xE27
Dimmable according to bulb

Classe I IP54

Unit: cm

_ ADDITIONAL ACCESORIES

BASE MOBILE

Accessory for TAKÉ OPEN AIR 03 - 10 - 11 - 21

■ 103 Black FT

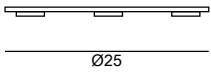
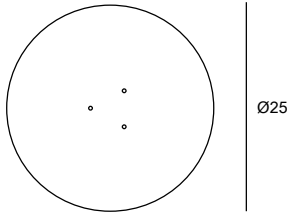

Unit: cm

PICKET

Accessory for TAKÉ OPEN AIR 03 - 10 - 11 - 21

■ 103 Black FT

$\varnothing 7$

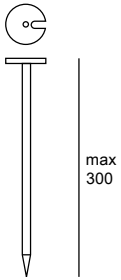

Unit: cm

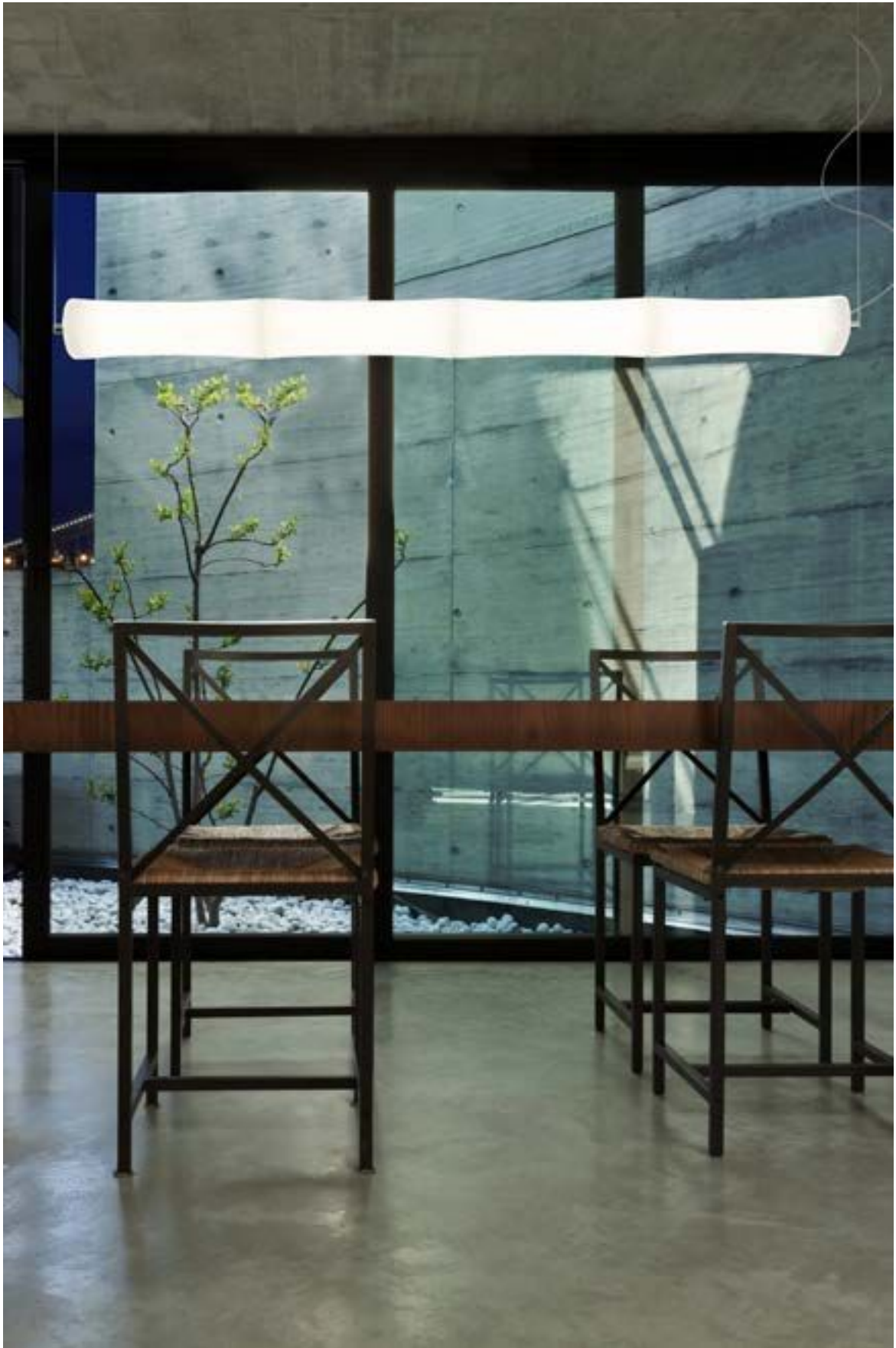



_ TØB

Design B. Rasmussen

L'ESSENZA DELLA LUCE

Disegnata da Brian Rasmussen, TØB bilancia con semplicità il minimalismo dei profili, la ricercatezza dei dettagli insieme alla calda preziosità dei materiali utilizzati.

THE ESSENCE OF LIGHT

Designed by Brian Rasmussen, TØB balances with simplicity the minimalism of its profiles, the refined intricacy of details, and the warm preciousness of the materials used.

L'ESSENCE DE LA LUMIÈRE

Dessinée par Brian Rasmussen, TØB concilie avec simplicité le minimalisme des profils, le raffinement des détails et la préciosité chaleureuse des matériaux utilisés.

DIE ESSENZ DES LICHTS

Das von Brian Rasmussen entworfene TØB gleicht auf einfache Weise den Minimalismus der Profile, die Verfeinerung der Details und die warme Kostbarkeit der verwendeten Materialien aus.

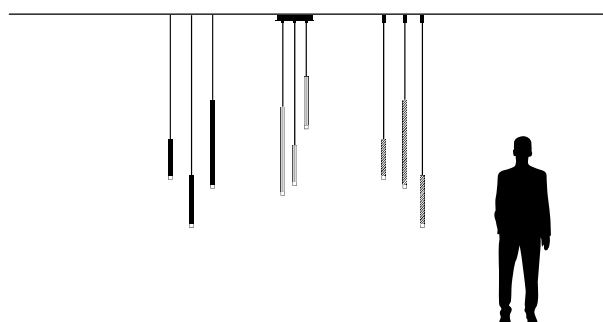

TØB 30 - 50 - 80**Suspension lamp**

—
Lampada a sospensione realizzata in ottone, disponibile in tre lunghezze (33, 53 e 83 cm) e nelle versioni liscio (line), scanalato (stripes) e cordonato (twist). Sorgente LED integrata ed alimentatore elettronico incluso solo nei rosoni; grazie ai quali è possibile creare composizioni libere. Disponibile in ottone lucido, cromo e nichel nero con rosoni in bianco ft o nero ft.

—
Suspension lamp made of brass, available in three lengths (33, 53 and 83 cm) and in smooth brass (line), grooved brass (stripes), and twisted brass (twist). Embedded LED lighting source and power supply included in the ceiling roses only, thanks to which free compositions can be created. Available in polished brass, chrome and black nickel with ceiling roses in white ft or black ft.

—
Suspension en laiton, disponible en trois longueurs (33, 53 et 83 cm) et en version lisse (line), rainurée (stripes) et torsadée (twist). Source LED intégrée et driver électronique inclus uniquement dans les rosaces permettant de créer des compositions personnalisées. Disponible en laiton poli, chrome et nickel noir avec des rosaces en blanc ft ou noir ft.

—
Hängelampe aus Messing, verfügbar in drei Längen (33, 53 und 83 cm) und in aus glattem Messing (Line), gerilltem Messing (Stripes) und gedrehtem Messing (Twist). Integrierte LED-Lichtquelle und TRIAC dimmbare Stromversorgung nur in den Deckenrosetten enthalten, dank derer freie Kompositionen möglich sind. Erhältlich in poliertem Messing, Chrom und schwarzem Nickel mit Deckenrosetten in weißem oder schwarzem Fuß.





TØB LINE 30

Suspension lamp

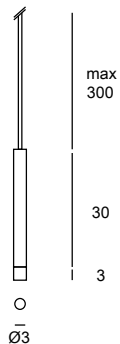

150 Chrome
153 Polished Brass
157 Black Nickel

LED 5W 540lm 2700K CRI>90
LED 5W 600lm 3000K CRI>90
Dimmable TRIAC
Driver not included

CE  Classe I IP20

Unit: cm

TØB LINE 50

Suspension lamp

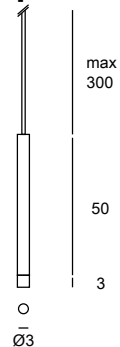

150 Chrome
153 Polished Brass
157 Black Nickel

LED 5W 540lm 2700K CRI>90
LED 5W 600lm 3000K CRI>90
Dimmable TRIAC
Driver not included

CE  Classe I IP20

Unit: cm

TØB LINE 80

Suspension lamp

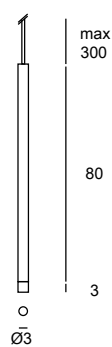

150 Chrome
153 Polished Brass
157 Black Nickel

LED 5W 540lm 2700K CRI>90
LED 5W 600lm 3000K CRI>90
Dimmable TRIAC
Driver not included

CE  Classe I IP20

Unit: cm

TØB STRIPES 30
Suspension lamp

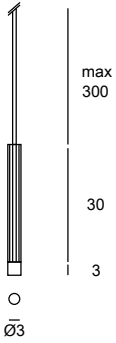

- 150 Chrome
- 153 Polished Brass
- 157 Black Nickel

LED 5W 540lm 2700K CRI>90
LED 5W 600lm 3000K CRI>90
Dimmable TRIAC
Driver not included

CE Classe I IP20

Unit: cm

TØB STRIPES 50
Suspension lamp

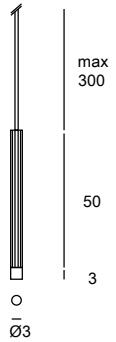

- 150 Chrome
- 153 Polished Brass
- 157 Black Nickel

LED 5W 540lm 2700K CRI>90
LED 5W 600lm 3000K CRI>90
Dimmable TRIAC
Driver not included

CE Classe I IP20

Unit: cm

TØB STRIPES 80
Suspension lamp

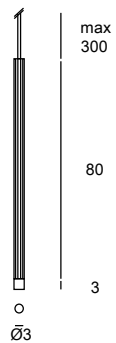

- 150 Chrome
- 153 Polished Brass
- 157 Black Nickel

LED 5W 540lm 2700K CRI>90
LED 5W 600lm 3000K CRI>90
Dimmable TRIAC
Driver not included

CE Classe I IP20

Unit: cm

TØB TWIST 30 Suspension lamp

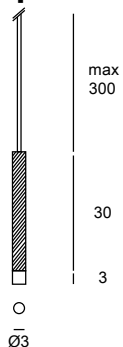

150 Chrome
153 Polished Brass
157 Black Nickel

LED 5W 540lm 2700K CRI>90
LED 5W 600lm 3000K CRI>90
Dimmable TRIAC
Driver not included

CE  Classe I IP20

Unit: cm

TØB TWIST 50 Suspension lamp

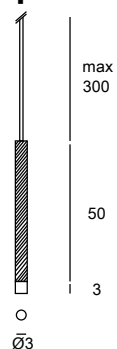

150 Chrome
153 Polished Brass
157 Black Nickel

LED 5W 540lm 2700K CRI>90
LED 5W 600lm 3000K CRI>90
Dimmable TRIAC
Driver not included

CE  Classe I IP20

Unit: cm

TØB TWIST 80 Suspension lamp

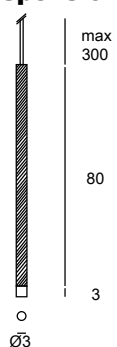

150 Chrome
153 Polished Brass
157 Black Nickel

LED 5W 540lm 2700K CRI>90
LED 5W 600lm 3000K CRI>90
Dimmable TRIAC
Driver not included

CE  Classe I IP20

Unit: cm

_ CEILING ROSES

ROS-DRI

Ceiling rose

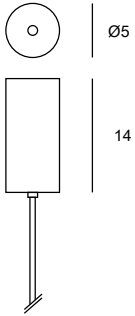

- 103 Black ft
- 105 White FT

Dimmable driver TRIAC included

Unit: cm

ROS-IN-DRI

Ceiling rose

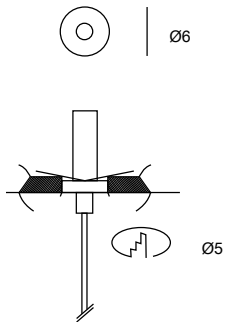

- 103 Black ft
- 105 White FT

Dimmable driver TRIAC included

Unit: cm

ROS-MULTI-DRI3/ ROS-MULTI-DRI6

Ceiling rose

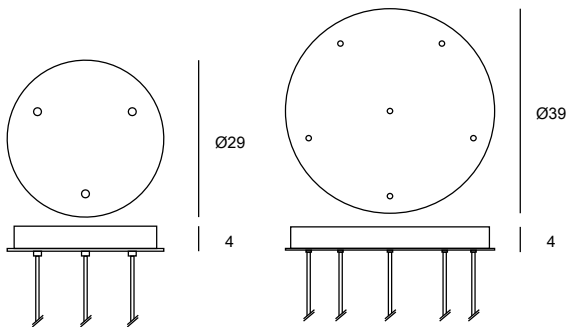

- 103 Black ft
- 105 White FT

Dimmable driver TRIAC included

Unit: cm

_ Ego Family







_ Ego Family

Design VillaTosca

MINIMALISMO INDUSTRIALE

Ego è il perfetto connubio tra il design minimalista e il carattere tipicamente industriale del profilo e dell'estetica dei materiali.

INDUSTRIAL MINIMALISM

Ego is the perfect combination of minimalist design and the typically industrial style of the profile and aesthetic of their materials

MINIMALISME INDUSTRIEL

Ego est la combinaison parfaite entre le design minimaliste et le style typiquement industriel du profil et de l'esthétique des matériaux.

INDUSTRIELLER MINIMALISMUS

Ego ist die perfekte Kombination aus minimalistischem Design und dem typischen industriellen Stil des Profils und der Ästhetik der Materialien.

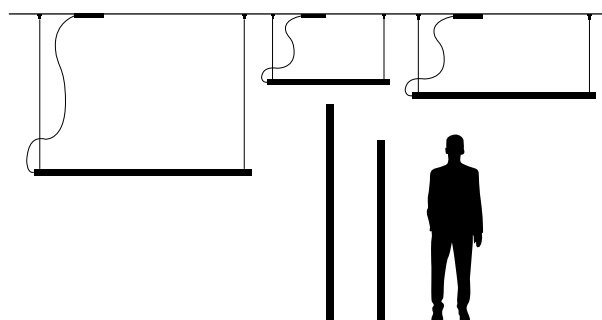

EGO L - XL - XXL**Suspension lamp**

—
Lampada a sospensione realizzata in alluminio disponibile in 3 lunghezze con diffusore in PMMA bianco opale. Sorgente LED integrata ed alimentatore elettronico dimmerabile TRIAC. Disponibile in bianco ft, nero ft e red brown ft.

—
Suspension lamps available in 3 lengths with white opal PMMA diffuser and embedded LED lighting source and TRIAC dimmable power supply. Available in white ft, black ft and red brown ft.

—
Suspension en aluminium disponible en trois longueurs différentes avec diffuseur en PMMA blanc opale. Source LED intégrée et driver dimmable TRIAC. Disponible en blanc ft, noir ft et red brown ft.

—
Hängelampen verfügbar in 3 Längen. Weißer opaler PMMA-Diffusor und integrierte LED-Lichtquelle und TRIAC dimmbare Stromversorgung im Lampenkörper. Verfügbar in weiß ft, schwarz ft und rotbraun ft.

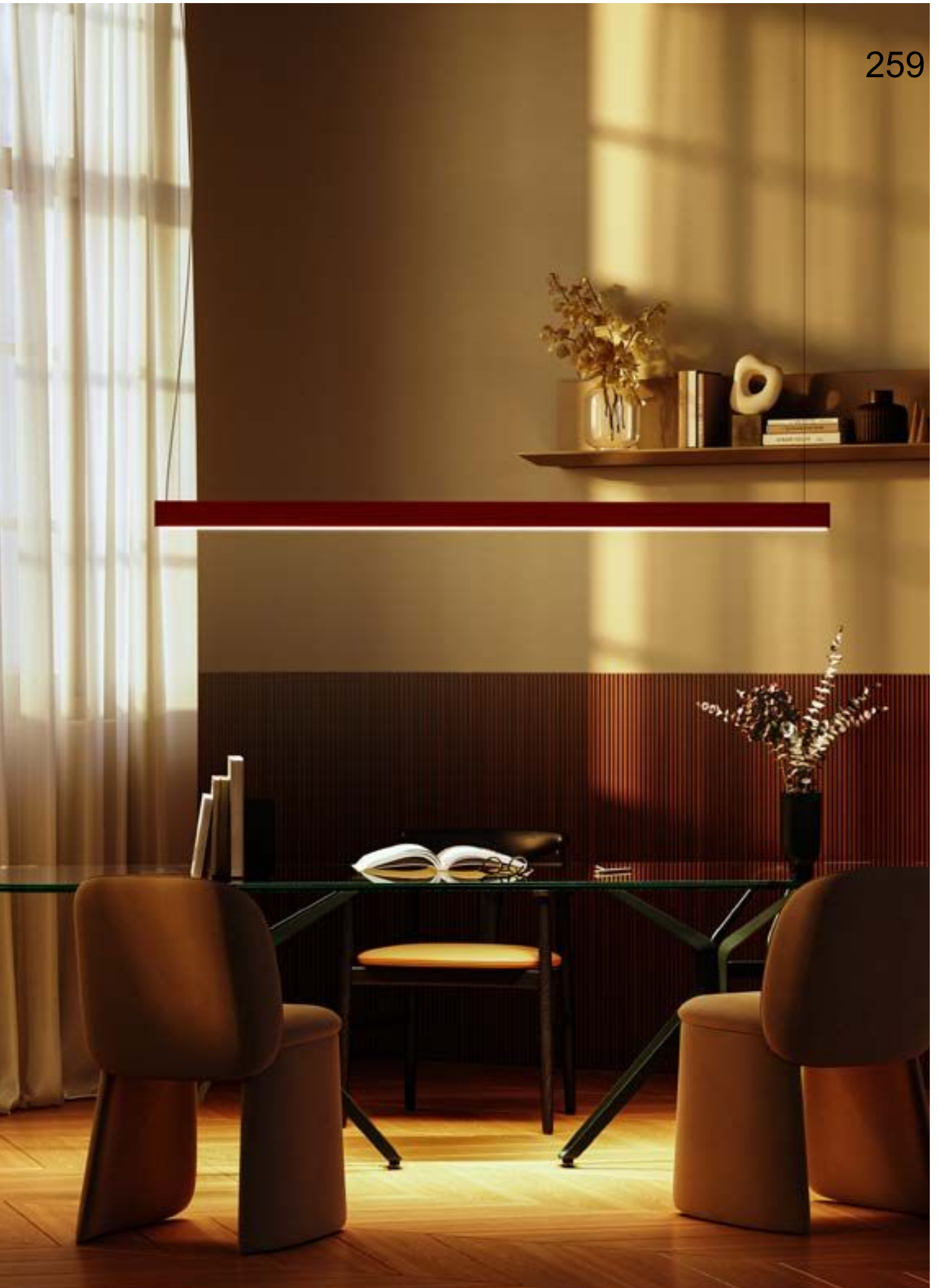

EGO 11 - 12**Floor lamp**

—
Lampada da terra realizzata in alluminio disponibile in 2 altezze con diffusore in PMMA bianco opale. Sorgente LED integrata e push dimmer su corpo lampada. Disponibile in bianco ft, nero ft e red brown ft.

—
Floor lamp made of aluminium, available in two lengths. White opal PMMA diffuser and embedded LED lighting source and push dimmable power supply on the lamp's body. Available in white ft, black ft and red brown ft.

—
Lampadaire en aluminium et disponible en deux hauteurs avec diffuseur en PMMA blanc opale. Source LED intégrée et variateur d'intensité avec bouton poussoir sur le corps de la lampe. Disponible en blanc ft, noir ft et red brown ft.

—
Stehlampe aus Aluminium, verfügbar in zwei Längen. Weißer opaler PMMA-Diffusor und integrierte LED-Lichtquelle und push dimmbare Stromversorgung im Lampenkörper. Verfügbar in weiß ft, schwarz ft und rotbraun ft.



EGO 11
Floor lamp

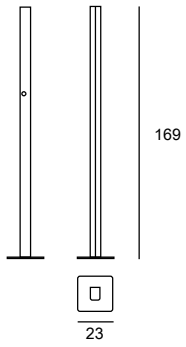

- 103 Black FT
- 105 White FT
- 138 Red-Brown FT

LED 34W 4080lm 2700K CRI>90
LED 34W 4080lm 3000K CRI>90
Push dimmer on the structure

CE IP20

Unit: cm

EGO 12
Floor lamp

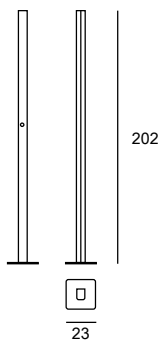

- 103 Black FT
- 105 White FT
- 138 Red-Brown FT

LED 40W 4800lm 2700K CRI>90
LED 40W 4800lm 3000K CRI>90
Push dimmer on the structure

CE IP20

Unit: cm

EGO L

Suspension lamp

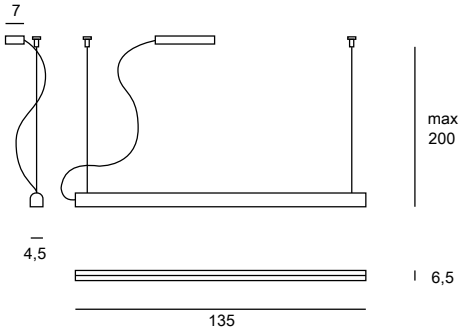

- 103 Black FT
- 105 White FT
- 138 Red-Brown FT

LED 28W 3360lm 2700K CRI>90
 LED 28W 3360lm 3000K CRI>90
 Dimmable TRIAC

CE Classe I IP20

Unit: cm

EGO XL

Suspension lamp

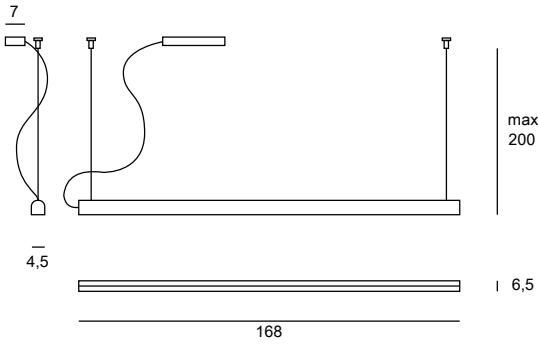

- 103 Black FT
- 105 White FT
- 138 Red-Brown FT

LED 34W 4080lm 2700K CRI>90
 LED 34W 4080lm 3000K CRI>90
 Dimmable TRIAC

CE Classe I IP20

Unit: cm

EGO XXL

Suspension lamp

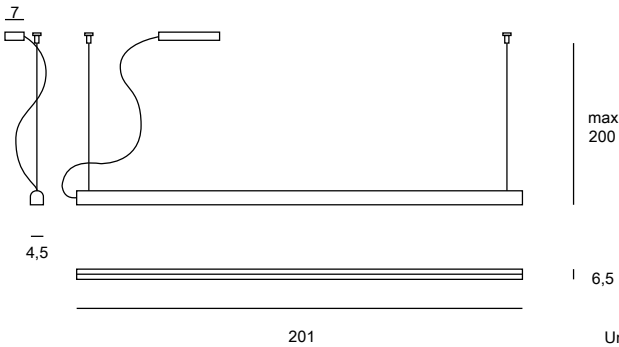

- 103 Black FT
- 105 White FT
- 138 Red-Brown FT

LED 40W 4800lm 2700K CRI>90
 LED 40W 4800lm 3000K CRI>90
 Dimmable TRIAC

CE Classe I IP20

Unit: cm



Concorde

Design VillaTosca

MONOLITE LUMINOSO

Affusolata e statuaria come un monolite, Concorde cita l'obelisco della celebre piazza della Ville Lumière a pochi passi dagli Champs-Élysées e ne rielabora la silhouette in una linea semplice e stilizzata.

BRIGHT MONOLITH

Tapered and statuesque as a monolith, Concorde recalls the obelisk of the renowned square of the Ville Lumière, a few steps from the Champs Élysées, and reinterprets its silhouette with a simple, stylized line.

MONOLITHE LUMINEUX

Élancé et sculptural comme un monolithe, Concorde évoque l'obélisque de la célèbre place de la Ville Lumière à quelques pas des Champs-Élysées et retravaille sa silhouette dans une ligne simple et stylisée.

GLÄNZENDER MONOLITH

Schmal und statuenhaft, erinnert Concorde an die Obelisken des bekannten Platzes der Ville Lumière, der nur wenige Schritte von den eleganten Champs-Élysées ist. Sie reinterpretiert die Silhouette mit einer einfachen, stilisierten Linie.

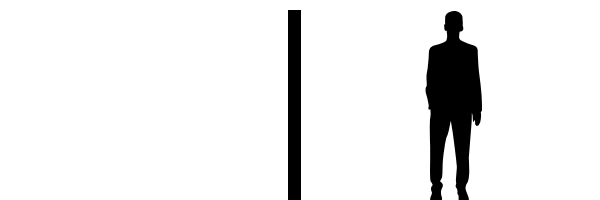

CONCORDE

Floor lamp



– Lampada da terra realizzata in alluminio ed ottone con dettagli cromati sulla sommità e lo scuretto della base che alleggeriscono e rendono piacevole la semplicità della forma. Sorgente LED integrata a luce indiretta e push dimmer su corpo lampada. Disponibile in bianco ft, nero ft e red brown ft.

– Floor lamp made of aluminium and brass with chrome details on the top and the dark hues at the base that slim its profile and create a pleasant simplicity of form. Embedded indirect LED lighting source and push dimmer on the body lamp. Available in white ft, black ft and red brown ft.

– Lampadaire en aluminium et laiton présentant des détails chromés sur partie supérieure ; l'assombrissement de la base éclaire et agrément la simplicité de la forme. Source LED intégrée avec lumière indirecte et variateur d'intensité avec bouton poussoir sur le corps du lampadaire. Disponible en blanc ft, noir ft et red brown ft.

– Stehlampe aus Aluminium und Messing mit verchromten Details an der Oberseite und den dunklen Farbtönen an der Basis, die das Profil verschlanken und eine angenehme Einfachheit der Form schaffen. Integrierte indirekte LED-Lichtquelle und push Dimmer auf dem Körper der Lampe. Verfügbar in weiß ft, schwarz ft und rotbraun ft.

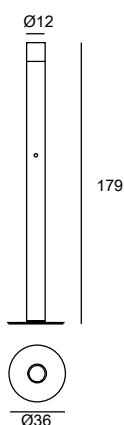

103 Black FT
105 White FT
138 Red-Brown FT

LED 50W 4800lm 2700K CRI>90
Push dimmer on the structure

CE V IP20

Unit: cm





Gilles

Design VillaTosca

DESIGN COMPATTO, DOPPIA LUMINOSITÀ

Disegnata da VillaTosca, Gilles compatta ed essenziale è stata progettata per unire una grande potenza luminosa ad un design ridotto e funzionale.

COMPACT DESIGN, DUAL LIGHTING

Designed by VillaTosca, Gilles is a compact and essential light that was projected to blend great lighting power with a small, functional design.

DESIGN COMPACT, DOUBLE LUMINOSITÉ

Dessinée par VillaTosca, la lampe Gilles, au design compact et essentiel, a été conçue pour réunir une grande puissance d'éclairage et un design sobre et fonctionnel.

KOMPAKTES DESIGN, DOPPELTE BELEUCHTUNG

Die von VillaTosca entworfene Gilles ist eine kompakte und unentbehrliche Leuchte, die eine große Beleuchtungsleistung mit einem kleinen, funktionellen Design verbindet.

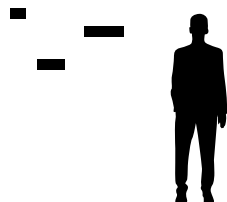

GILLES S - M - L**Wall lamp**

—
Lampada da parete realizzata in alluminio estruso e disponibile in 3 lunghezze, consente di avere un doppio fascio luminoso orientato verso il basso e verso l'alto. Sorgente LED integrata ed alimentatore elettronico dimmerabile TRIAC. Disponibile in bianco ft, nero ft, grigio sabbia ft ed oro verniciato.

—
Wall lamp made of extruded aluminium and available in three sizes with a double light beam that can be directed upwards or downwards. Embedded LED lighting source and TRIAC dimmable power supply. Available in white ft, black ft, grey sand ft and painted gold.

—
Applique murale en aluminium extrudé disponible en 3 longueurs, permet de diffuser un double faisceau lumineux orienté vers le bas et vers le haut. Source LED intégrée et driver dimmable TRIAC. Disponible en blanc ft, noir ft, gris sable ft et or peint.

—
Wandlampe aus extrudiertem Aluminium und verfügbar in drei Größen mit einem doppelten mit mit einem doppelten Lichtstrahl, der nach oben oder unten gerichtet werden kann. Integrierte LED-Lichtquelle und TRIAC dimmbare Stromversorgung. Verfügbar in weiß ft, schwarz ft, sandgrau und lackiertem Gold.



GILLES S Wall lamp

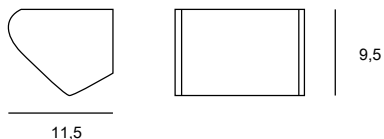

- 103 Black FT
- 105 White FT
- 115R Sand grey FT
- 164 Painted Gold

UP LED 15W
DOWN LED 5W
2400lm 2700K or 3000K CRI>90
Dimmable TRIAC

Classe I IP20

Unit: cm

GILLES M Wall lamp

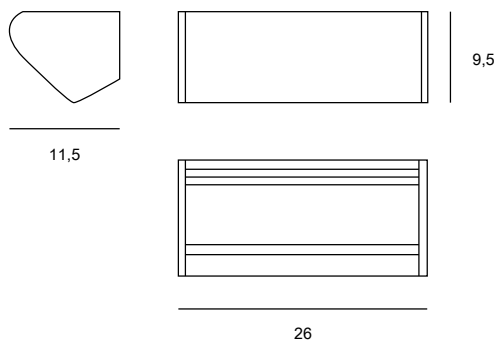

- 103 Black FT
- 105 White FT
- 115R Sand grey FT
- 164 Painted Gold

UP LED 30W
DOWN LED 510
4800lm 2700K or 3000K CRI>90
Dimmable TRIAC

Classe I IP20

Unit: cm

GILLES L Wall lamp

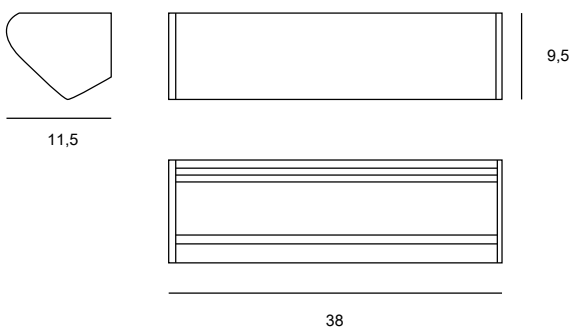

- 103 Black FT
- 105 White FT
- 115R Sand grey FT
- 164 Painted Gold

UP LED 45W
DOWN LED 15W
7200lm 2700K or 3000K CRI>90
Dimmable TRIAC

Classe I IP20

Unit: cm

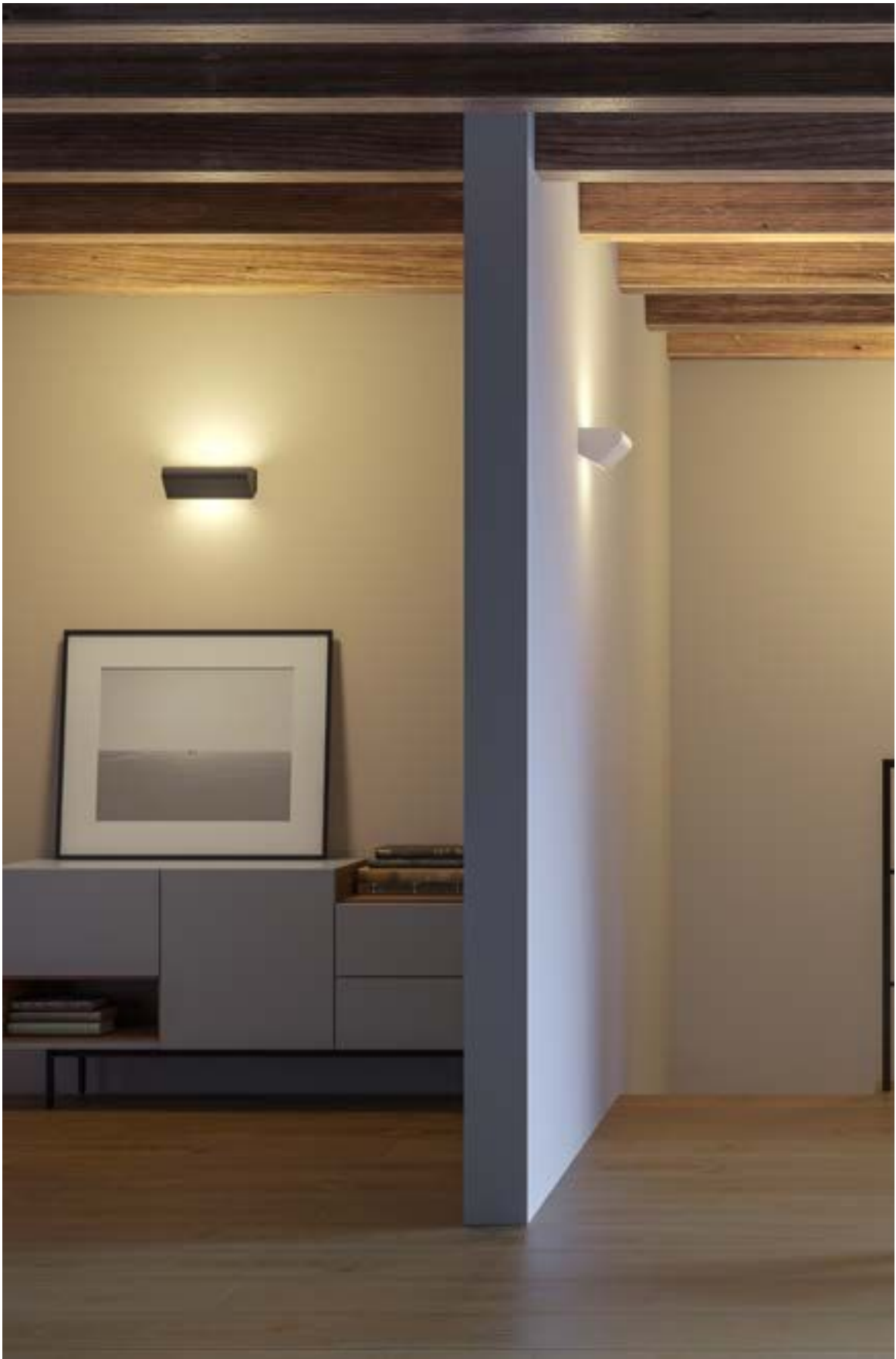



_ Hinode

Design Setsu&Shinobu Ito

ORIZZONTE LUMINOSO

Disegnata da Sestu&Shinobu Ito, Hinode si ispira alla luce del giorno che sorge e tramonta sulla linea dell'orizzonte.

BRIGHT HORIZON

Designed by Sestu&Shinobu Ito, Hinode is inspired by daylight that rises and then sets on the horizon.

HORIZON LUMINEUX

Dessinée par Setsu&Shinobu Ito, Hinode s'inspire de la lumière du jour se détachant sur l'horizon au lever et au coucher du soleil.

BREITER HORIZONT

Entworfen von Sestu&Shinobu Ito, wurde Hinode vom Sonnenaufgangslicht an dem Horizont inspiriert.

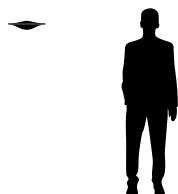

HINODE
Wall lamp



—
Lampada da parete realizzata in alluminio pressofuso che attraverso una fessura nel corpo lampada emette sia luce diretta che indiretta. Sorgente LED integrata ed alimentatore elettronico dimmerabile TRIAC. Disponibile in bianco ft e nero ft.

—
Wall lamp made of die cast aluminium. Through an opening in the lamp body, it emits both direct and indirect light. LED lighting source and TRIAC dimmable power supply. Available in white ft and black ft.

—
Applique murale en aluminium moulé sous pression qui diffuse une lumière directe et indirecte à travers une fente dans le corps de la lampe. Source LED intégrée et driver dimmable TRIAC. Disponible en blanc ft et noir ft.

—
Wandlampe aus Aluminiumdruckguss, die direktes und indirektes Licht durch eine Ritze im Lampenkörper ausstrahlt. Integrierte LED-Lichtquelle und TRIAC dimmbare Stromversorgung. Verfügbar in weiß ft und schwarz ft.

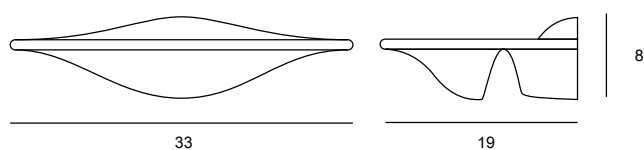

■ 103 Black FT
□ 105 White FT

LED 42W 3850lm 3000K CRI>90
Dimmable Dali/Push

CE  Classe I IP20



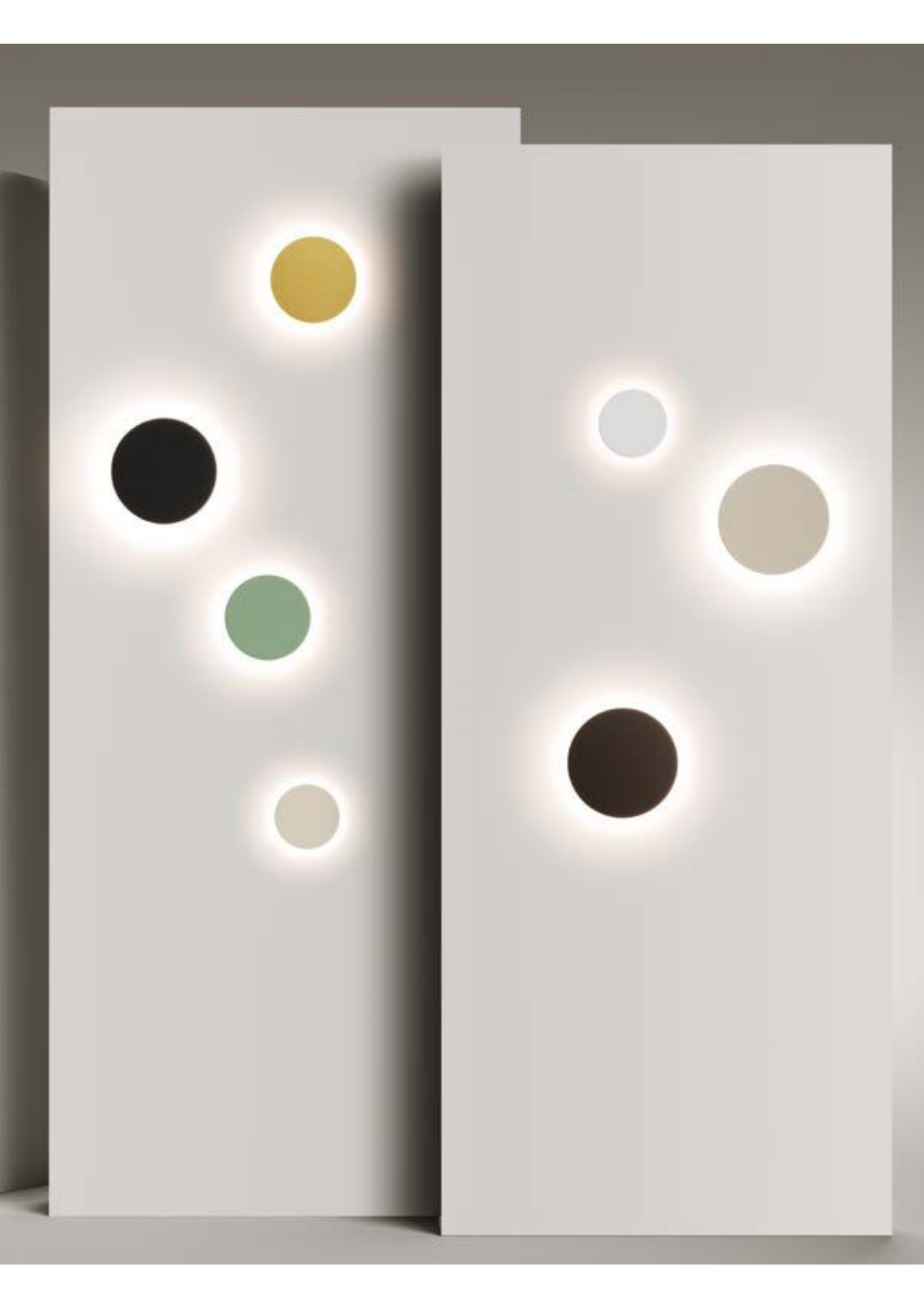

_ Brawall

Design LCI.LAB

GEOMETRIE DI LUCE

Brawall è caratterizzata da un semplice e perfetto profilo circolare con cui si possono creare suggestive ed eleganti composizioni luminose.

GEOMETRIES OF LIGHT

Brawall is characterized by a simple, perfect circular profile with which one can create striking and elegant lighting compositions.

GÉOMÉTRIES LUMINEUSES

Brawall se caractérise par un profil circulaire simple et parfait qui permet de créer des compositions lumineuses recherchées et élégantes.

GEOMETRIE AUS LICHT

Brawall zeichnet sich durch ein einfaches, perfekt kreisförmiges Profil, der die Kreation von auffälligen, eleganten Lichtkompositionen ermöglicht.

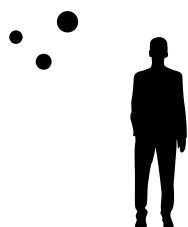

BRAWALL S - M - L**Wall lamp**

—
Lampada da parete realizzata in pressofusione d'alluminio laccato e disponibile in 3 diametri. Sorgente LED integrata a luce indiretta e alimentatore elettronico ON-OFF. Disponibile in bianco ft, nero ft, grigio sabbia ft, verde salvia ft, oro verniciato e bronzo verniciato.

—
Wall lamp made in die cast aluminium and available in 3 different diameters. Indirect LED lighting source and ON-OFF electronic power supply. Available in white ft, black ft, sand grey ft, sage green ft, painted gold and painted bronze.

—
Applique murale en aluminium laqué moulé sous pression et disponible en 3 diamètres. Source LED intégrée avec lumière indirecte et alimentation électronique ON-OFF. Disponible en blanc ft, noir ft, gris sable ft, vert sauge ft or peint et bronze peint.

—
Wandlampe aus Aluminiumdruckguss, erhältlich in 3 verschiedenen Durchmesser. Indirekte LED-Lichtquelle und ON-OFF elektronische Stromversorgung. Verfügbar in weiß ft, schwarz ft, sandgrau ft, salbeigrün ft, lackierten Gold und lackierter Bronze.



BRAWALL S

Wall lamp

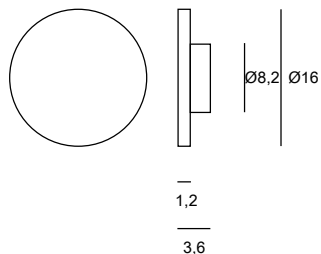

- 103 Black FT
- 105 White FT
- 115R Sand grey FT
- 126 Sage Green FT
- 164 Painted Gold
- 175 Painted Bronze

LED 6W 330lm 2700K or 3000K CRI>90
ON-OFF

CE Classe I IP20

Unit: cm

BRAWALL M

Wall lamp

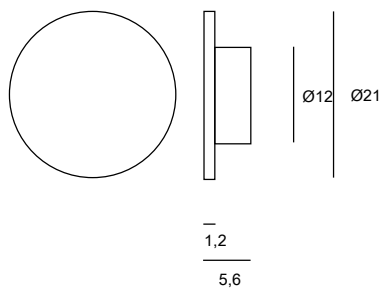

- 103 Black FT
- 105 White FT
- 115R Sand grey FT
- 126 Sage Green FT
- 164 Painted Gold
- 175 Painted Bronze

LED 12W 801lm 2700K or 3000K CRI>90
ON-OFF

CE Classe I IP20

Unit: cm

BRAWALL L

Wall lamp

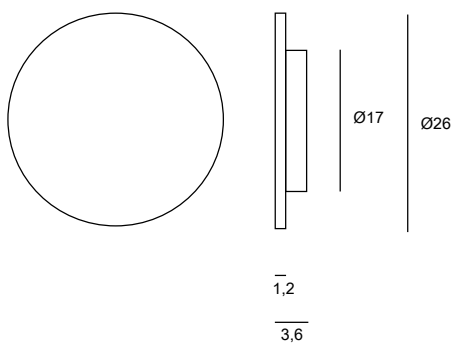

- 103 Black FT
- 105 White FT
- 115R Sand grey FT
- 126 Sage Green FT
- 164 Painted Gold
- 175 Painted Bronze

LED 18W 1264lm 2700K or 3000K CRI>90
ON-OFF

CE Classe I IP20

Unit: cm



_ Brac-Brick-Domino System



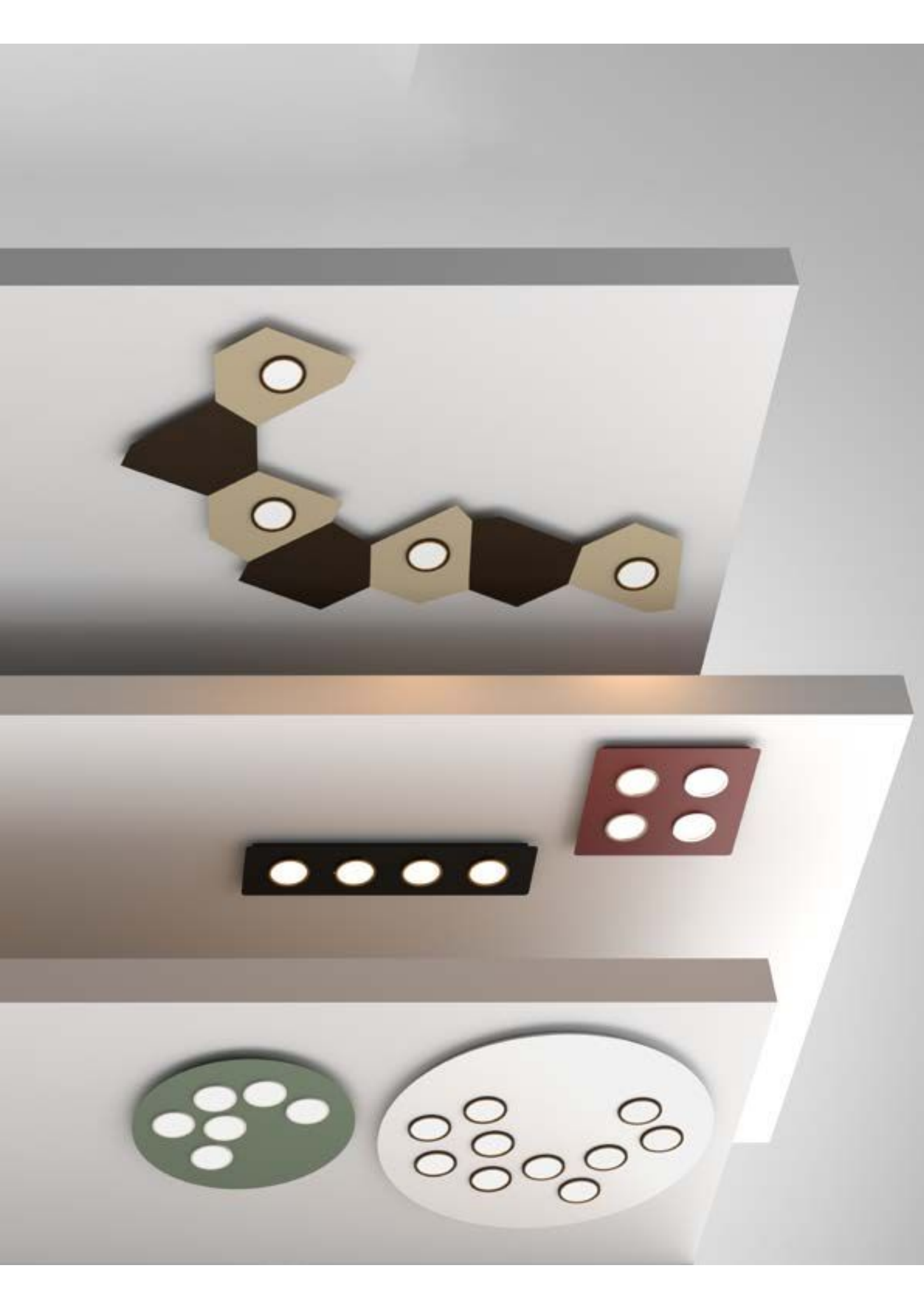



Brick-Brac-Domino

Design VillaTosca Design

GEOMETRIE DI LUCE

Ingenuità, rigore e design essenziale si incontrano nella collezione di plafoniere Brac, Brick e Domino nei quali sono iscritti piccoli cerchi di luce. Piccole gocce luminose sono distribuite con apparente casualità sulla superficie di Brick e Brac. Attraverso la particolare forma del sistema Domino si possono creare liberamente mosaici e composizione di luci.

GEOMETRIES OF LIGHT

Ingenuity, rigor and essential design combine in the ceiling lamps collection Brac, Brick and Domino in which circles of light are fashioned. Small luminous drops are scattered with apparent causality along the surface of Brick and Brac. Through the particular form of the Domino system mosaics and light compositions can be freely created.

GÉOMÉTRIES LUMINEUSES

La collection de plafonniers Brac, Brick et Domino, dans lesquels s'inscrivent des petits cercles de lumière, est un parfait mélange d'ingéniosité, de rigueur et de design épuré. De petites gouttes de lumière sont distribuées de façon apparemment aléatoire sur la surface de Brick et de Brac. La forme particulière du système Domino permet de créer en toute liberté des mosaïques et des compositions lumineuses.

GEOMETRIEN AUS LICHT

Naivität und Rigor verschmelzen sich miteinander in der Familie der Deckenlampen Brac, Brick und Domino, in der Lichtkreise geformt sind. Kleine, glänzende Tropfen sind mit scheinbarer Kausalität auf der runden Oberfläche von Brick und Brac verbreitet. Durch die besondere Form des Domino Systems können Mosaik und Lichterkombinationen kreiert werden.





BRAC**Ceiling lamp**

—
Lampada da soffitto circolare realizzata in alluminio verniciato a 1, 4, 6 e 10 luci con sorgente LED integrata ed alimentatore elettronico dimmerabile TRIAC. Disponibile in diverse composizioni di colore personalizzabili grazie all'utilizzo del configuratore a pagina 300.

—
Circular ceiling lamps made of painted aluminium and available with 1, 4, 6, or 10 lights with embedded LED lighting source and TRIAC dimmable electronic power supply. Available in different colour compositions that can be customised using the configurator at page 300.

—
Plafonnier circulaire en aluminium peint composé de 1, 4, 6 et 10 lumières avec source LED intégrée et driver dimmable TRIAC. Différentes compositions de couleurs disponibles et personnalisables à l'aide du configurateur page 300.

—
Runde Deckenlampe aus lackiertem Metall und verfügbar mit 1, 4, 6 oder 10 Lichtern. Integrierte LED-Lichtquelle und TRIAC dimmbare elektronische Stromversorgung. Erhältlich in verschiedenen Farbkombinationen, die mit dem Konfigurator auf Seite 300 individuell gestaltet werden können.



BRICK**Ceiling lamp**

–
Lampada da soffitto quadrata o rettangolare realizzata in alluminio verniciato a 1, 2, 4 moduli con sorgente LED integrata ed alimentatore elettronico dimmerabile TRIAC. Disponibile in diverse composizioni di colore personalizzabili grazie all'utilizzo del configuratore a pagina 300.

–
Square or rectangular ceiling lamps made of painted aluminium and available with 1, 2 or 4 modules with embedded LED lighting source and TRIAC dimmable electronic power supply. Available in different colour compositions that can be customised using the configurator at page 300.

–
Plafonnier carré ou rectangulaire en aluminium peint comprenant 1, 2, 4 modules avec source LED intégrée et driver dimmable TRIAC. Différentes compositions de couleurs disponibles et personnalisables à l'aide du configurateur page 300.

–
Viereckige und rechteckige Deckenlampe aus Metall und mit 1,2 oder 4 Lichtern. Integrierte LED-Lichtquelle und TRIAC dimmbare elektronische Stromversorgung. Erhältlich in verschiedenen Farbkombinationen, die mit dem Konfigurator auf Seite 300 individuell gestaltet werden können.

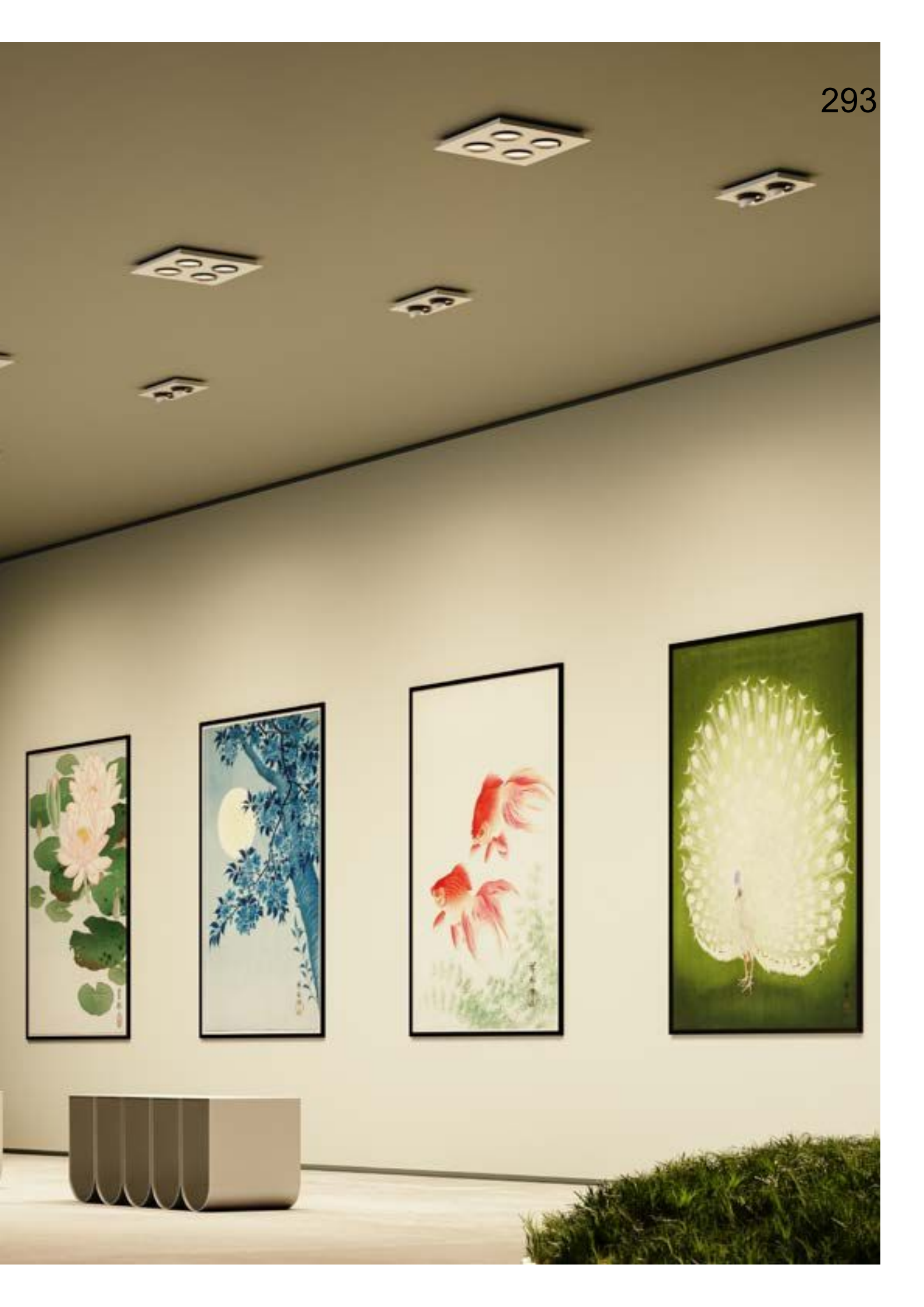

DOMINO**Ceiling lamp**

—
Lampada da soffitto modulare realizzata in alluminio verniciato con sorgente LED integrata ed alimentatore elettronico dimmerabile TRIAC. Disponibile in diverse combinazioni di colore personalizzabili grazie all'utilizzo del configuratore a pagina 300.

—
Modular ceiling lamps made of painted aluminium with embedded LED lighting source and TRIAC dimmable electronic power supply. Available in different colour compositions that can be customised using the configurator at page 300.

—
Plafonnier modulaire réalisé en aluminium peint, équipé d'une source LED intégrée et d'un driver dimmable TRIAC. Différentes compositions de couleurs disponibles et personnalisables à l'aide du configurateur page 300.

—
Modulare Deckenlampe aus lackiertem Metall. Integrierte LED-Lichtquelle und TRIAC dimmbare, elektronische Stromversorgung. Erhältlich in verschiedenen Farbkombinationen, die mit dem Konfigurator auf Seite 300 individuell gestaltet werden können.



BRAC 01 Ceiling lamp



Ø22

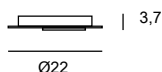

Ø22



See Configurator at page 300

LED 1x5,8W 690lm 2700K/3000K/4000K CRI>90
Dimmable TRIAC

CE  Classe I IP20

Unit: cm

BRAC 04 Ceiling lamp

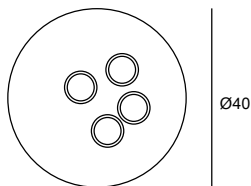

Ø40

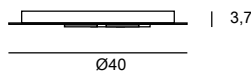

Ø40



See Configurator at page 300

LED 4x5,8W 2760lm 2700K/3000K/4000K CRI>90
Dimmable TRIAC

CE  Classe I IP20

Unit: cm

BRAC 06 Ceiling lamp

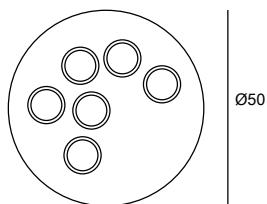

Ø50

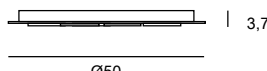

Ø50



See Configurator at page 300

LED 6x5,8W 4140lm 2700K/3000K/4000K CRI>90
Dimmable TRIAC

CE  Classe I IP20

Unit: cm

BRAC 10 Ceiling lamp

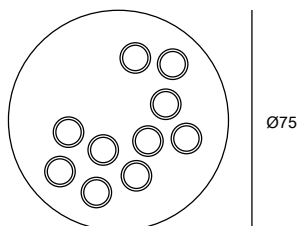

Ø75



Ø75



See Configurator at page 300

LED 10x5,8W 6950lm 2700K/3000K/4000K CRI>90
Dimmable TRIAC

CE  Classe I IP20

Unit: cm

BRICK QUADRO 01

Ceiling lamp

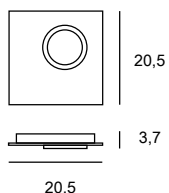

See Configurator at page 300

LED 1x5,8W 690lm 2700K/3000K/4000K CRI>90
Dimmable TRIAC

CE  Classe I IP20

BRICK QUADRO 04

Ceiling lamp

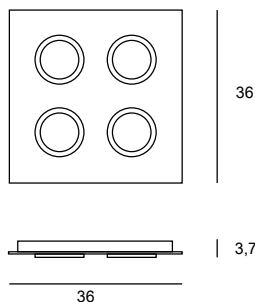

See Configurator at page 300

LED 4x5,8W 2760lm 2700K/3000K/4000K CRI>90
Dimmable TRIAC

CE  Classe I IP20

Unit: cm

BRICK RETTO 02

Ceiling lamp

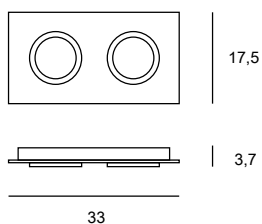

See Configurator at page 300

LED 2x5,8W 1380lm 2700K/3000K/4000K CRI>90
Dimmable TRIAC

CE  Classe I IP20

Unit: cm

BRICK RETTO 04

Ceiling lamp

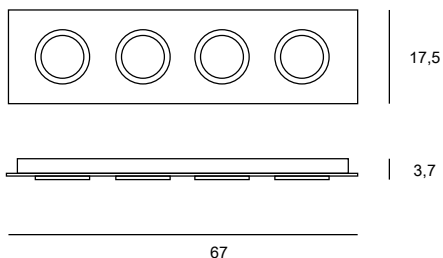

See Configurator at page 300

LED 4x5,8W 2760lm 2700K/3000K/4000K CRI>90
Dimmable TRIAC

CE  Classe I IP20

Unit: cm

DOMINO
Ceiling lamp

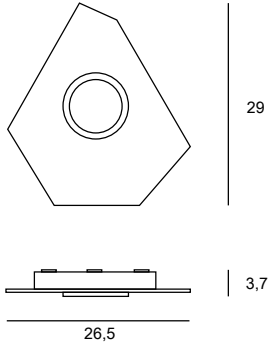

See Configurator at page 300

LED 1x5,8W 690lm 2700K/3000K/4000K CRI>90
Dimmable TRIAC

CE  Classe I IP20

Unit: cm

DOMINO ZERO
Ceiling lamp

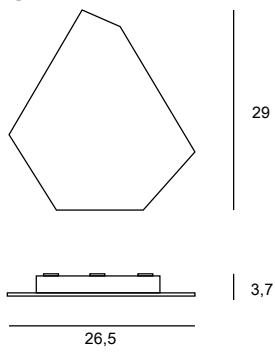

See Configurator at page 300

Unit: cm



_ Configurator



BASE



DRIVER



COLOUR TEMPERATURE



COVER



OPTIQUE





RING

1_ MODEL

BRAC 01
 BRAC 04
 BRAC 06
 BRAC 10
 BRICK QUADRO 01
 BRICK QUADRO 04
 BRICK RETTO 02
 BRICK RETTO 04
 DOMINO
 DOMINO ZERO

2_ BASE FINISH

 103 Black FT (B)
 105 White FT (W)

3_ COVER FINISH

 103 Black FT (B)
 105 White FT (W)
 115R Sand grey FT (S)
 126 Sage Green FT (G)
 138 Red Brown FT (R)
 175 Painted Bronze (P)

4_ RING FINISH

 103 Black FT (B)
 105 White FT (W)
 115R Sand grey FT (S)
 126 Sage Green FT (G)
 138 Red Brown FT (R)
 103 Chrome (C)
 164 Painted Gold (G)
 175 Painted Bronze (P)

5_ OPTIQUE

Wide (1)
 Medium (2)

6_ COLOUR TEMPERATURE

2700K (2)
 3000K (3)
 4000K (4)

7_ DRIVER

110 V (U)
 220 V (E)

8_ ACCESSORIES OPTIONAL

OKKIO SPOT

_ Colours & Finishes

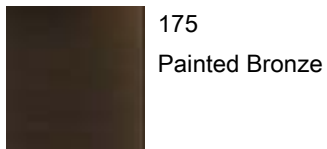
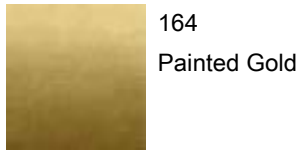
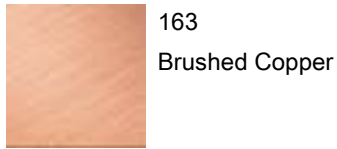
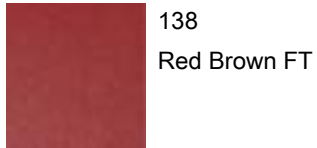
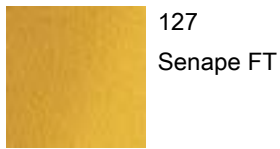
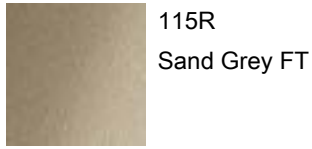
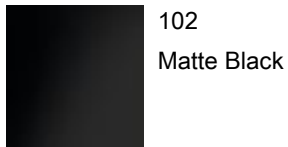
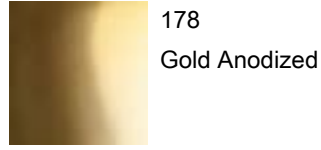
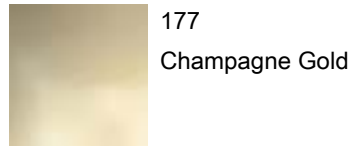
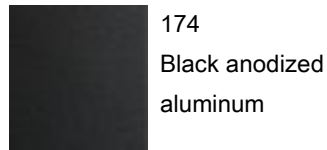
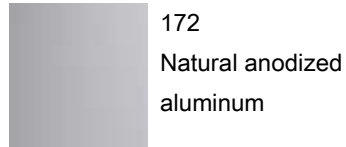
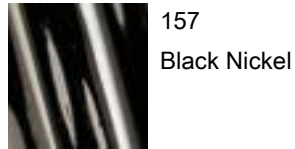
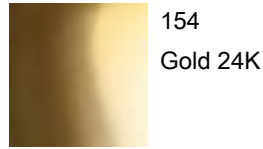
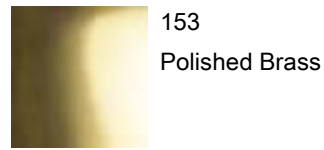
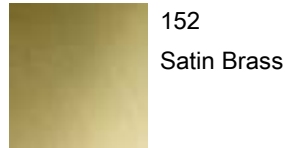
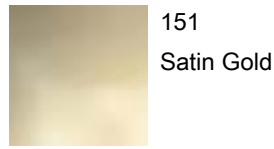
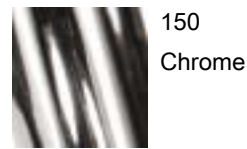
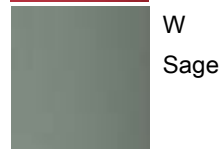
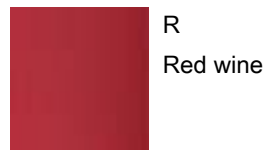
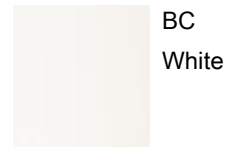
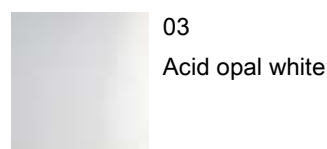
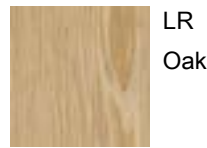
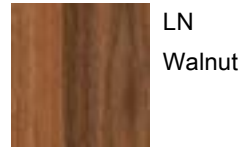
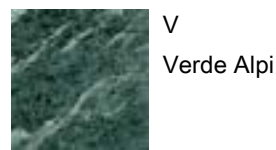
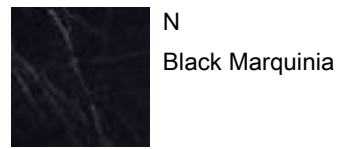
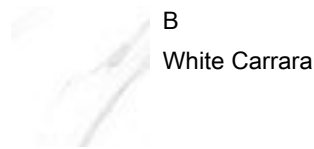
VERNICIATURA**PAINTING****ANODIZZATI****ANODIZED****GALVANICA****GALVANIC****TESSUTO****TEXTILE****VETRO****GLASS****LEGNO****WOOD****MARMO****MARBLE**

All LUMEN CENTER products that are part of the scope of the European low voltage directive BT 73/23 and consecutive amendment 93/68, meet the necessary requirements and bear the CE labeling. All dimensions are in cm unless otherwise indicated in the technical sheet. The assembly and maintenance instructions are included in the packages, as well as all certificates and warranty conditions. The indications about the materials and the finishes only refer to the main visible parts of the products. In general, the products are supplied without bulbs, unless otherwise indicated in the price list. LUMEN CENTER Italia Srl reserves the right to make any technical or formal modifications to the products contained in the catalogue, without any notice. All the data related to the bright efficiency emitted by our devices, are nominal and concerning to the specific technics of our bright sources (LED, halogen and fluorescent lamps) declared by the producer. The data of effective consumption and luminous emission, based on electric characteristics (potential differences and power supplies, dimming etc.) on physic and aesthetic of the devices (colour, material, type etc.) will be provided on customers demand.

Tutti i prodotti LUMEN CENTER che rientrano nell'ambito di applicazione della direttiva europea bassa tensione B.T. 73/23 e successiva modifica 93/68, soddisfano ai requisiti richiesti e recano la marcatura CE. Tutte le dimensioni sono espresse in cm salvo se diversamente indicato nella scheda tecnica. Le istruzioni di montaggio e di manutenzione sono incluse negli imballi, così come i certificati e le condizioni di garanzia. Le indicazioni relative a materiali e finiture riguardano solo le parti principali visibili dei prodotti. Generalmente i prodotti sono forniti senza lampadina salvo se diversamente indicato nel listino prezzi. LUMEN CENTER Italia Srl si riserva di apportare qualsiasi modifica tecnica o formale ai prodotti a catalogo senza dovere di preavviso. Tutti i dati relativi all'efficienza luminosa emessa dai nostri apparecchi, sono da intendersi nominali e riferiti alle specifiche tecniche delle sorgenti luminose (lampade a LED, alogene e fluorescenti) dichiarate dal costruttore. I dati di effettivo consumo ed emissione luminosa, basati sulle caratteristiche elettriche (tensioni e correnti di alimentazione, dimmerabilità ecc.), fisiche ed estetiche degli apparecchi (colore, materiale, tipologia ecc.), verranno fornite al cliente su specifica richiesta.

LUMEN
center.

Lumen Center Italia Srl
SEDE OPERATIVA
Via Donatori del Sangue, 37
20010 Santo Stefano Ticino (MI), Italy
Ph. (+39) 02 36544811
info@lumencenteritalia.com

SALES DEPARTMENT
tel. (+39) 02 3654 4310
sales@lumencenteritalia.com

GRAPHIC DESIGN & ART DIRECTION
Erika Nicole Visintin

LOGO
VZN Studio

3D IMAGES & PHOTOS
Zonelab
Nova Visualis
Emma Onesti
Minotti S.p.a.
Photo editing: Erika Nicole Visintin

COPYWRITING
Erika Nicole Visintin

TRANSLATION
EN_ Giulia Mancini
FR_ Delphine Guitton
DE_ Giulia Mancini

PRINT
Grafiche 2000 srl

March 2024

Questo documento è stato finito di stampare nel Marzo 2024.. I nostri prodotti sono in continua evoluzione, seguendo i progressi della tecnologia. Per rimanere sempre informati, vi invitiamo a visitare il nostro sito web, che viene aggiornato quotidianamente.

This document was finished printing in March 2024. Our products are constantly under development due to technological advancements. Please visit our website, which is daily updated.

